ЕЛЕКТРИЧНІ МАШИНИ ТА АПАРАТИ

УДК 621.313.8

DOI: <https://doi.org/10.15407/publishing2021.58.074>**EXPERIMENTAL STUDIES OF BRUSHLESS MAGNETOELECTRIC MOTORS OF THE RETURN-ROTARY MOTION****V.G. Kireyev***, **K.P. Akinin****, **A.A. Filomenko*****, **V.A. Lavrinenko**

Institute of Electrodynamics of the National Academy of Sciences of Ukraine,
pr. Peremohy, 56, Kyiv, 03057, Ukraine
e-mail: kvg2016@ukr.net

The paper describes the structure and mathematical model of a specialized brushless magnetolectric motor of return-rotary motion. The analysis of the parameters of the mathematical model is carried out and the methods of their experimental determination are described. Experimental frequency dependences of the rotor oscillations angle amplitude and the stator current effective value have been obtained. Based on the obtained parameters, the frequency characteristics of the motor were calculated and compared with the experimental dependences. Experimental oscillograms and calculated curves of stator voltages and currents are presented. References 7, figures 8.

Keywords: brushless magnetolectric motor, return-rotary motion, frequency characteristic, experimental study.

Introduction. An important stage in the creation of electric motors is their experimental studies. At the same time, the purpose of such studies can be to determine the parameters of mathematical models of motors, as well as to obtain their electromechanical characteristics, which makes it possible to assess the adequacy of the accepted assumptions.

Return-rotary motion systems based on electric motors are specialized electromechanical devices [1-4] designed to control the trajectories of the actuators with a given amplitude and frequency. In this case, to study their properties, it is necessary to take into account the features of both the motor itself and the conditions for implementing the modes of the return-rotary motion.

A feature of the brushless magnetolectric motor (BMM) of the return-rotary motion [5] considered in the paper is the setting of an additional permanent magnet to its structure in the gap between the coils of a single-phase stator winding, which allows realizing magnetic elastic coupling between the stator and the rotor. This addition provides an important advantage, which is the ability to position the motor shaft in the initial position. In this case, the return-rotary motion of the actuator in a limited angular range is carried out by acting on the stator winding with an alternating voltage. Therefore, the methods for studying the BMM of the return-rotary motion are different from the traditional approaches to the study of motors of rotary motion.

The purpose of the paper is to develop and study approaches to the experimental determination of the parameters and characteristics of a specialized BMM of the return-rotary motion.

The main material and research results. The structure of a specialized BMM [5] for controlling the return-rotary motion is shown in fig. 1.

Here, in body 1, there is a slotless magnetic circuit 5, as well as two bearings 2, in which the rotor shaft 3 with a bipolar permanent magnet 4 and an actuating element 9 are installed. On the inner surface of magnetic circuit 5 there are two coils 6 and 7 of the stator winding, and in the interval between which an additional permanent magnet 8 is installed to ensure a magnetic elastic coupling between the stator and the rotor.

Connecting the stator winding of the motor to an alternating voltage source with controlled amplitude and frequency allows the rotor to periodically deflect from the equilibrium position determined by the action of magnetic elastic coupling. In this case, the amplitude and frequency of the mechanical angular oscillations of the actuating element are determined by both the parameters of the control voltage and the properties of the motor.

The mathematical model of BMM for controlling return-rotary motion is described by the equations [6]:

$$L \frac{di}{dt} = -Ri - k_m \omega \cos \alpha + u; \quad (1)$$

$$M = k_m i \cos \alpha; \quad (2)$$

$$M_\omega = k_\omega \omega; \quad (3)$$

$$M_\alpha = k_\alpha \sin \alpha; \quad (4)$$

$$M_R = M_B \operatorname{sign}(\omega); \quad (5)$$

$$M_L = k_L \omega; \quad (6)$$

$$J \frac{d\omega}{dt} = M - M_\omega - M_\alpha - M_R - M_L; \quad (7)$$

$$\frac{d\alpha}{dt} = \omega. \quad (8)$$

From the consideration of the model, it can be seen that the motor variables are current i and control voltage u of the stator, angular speed ω and angle α of rotation of the rotor shaft, electromagnetic torque M of the motor, torques of viscous friction M_ω and elasticity M_α , reactive torque M_R of bearings and load torque M_L . At the same time, BMM parameters are inductance L and active resistance R of the stator winding, motor torques coefficient k_m , rotor moment J of inertia, coefficients of viscosity k_ω and elasticity k_α of the motor, the torque M_B of mechanical resistance of the bearings. The viscosity coefficient k_L of the mechanical load takes into account the parametric disturbance acting on the motor. In this study, we assume it to be zero.

In this paper, we will restrict ourselves to the study of the characteristics of the return-rotary motion with such variants of the formation of alternating stator voltage [6]

$$u = U_A \sin 2\pi f_o t; \quad (9)$$

$$u = U_A \operatorname{sign}(\sin(2\pi f_o t)); \quad (10)$$

where U_A is the amplitude of the stator voltage; f_o is the frequency of mechanical oscillations of the rotor shaft.

From the mathematical model of the dynamic state of the motor (1-8), it can be seen that the BMM of the return-rotary motion is described by the same parameters as some other permanent

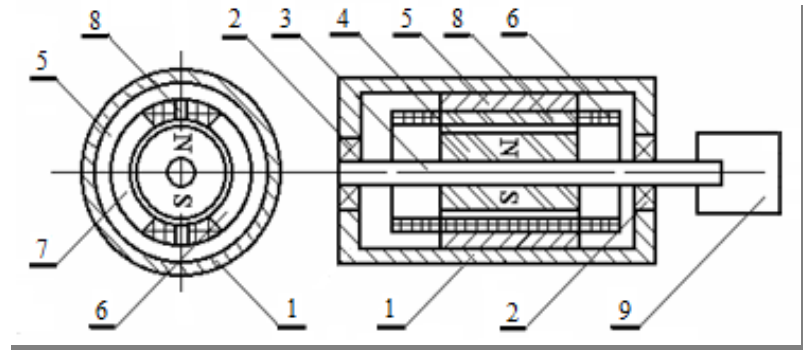

Fig. 1

magnet motors, however, the difference of this model consists in the presence of nonlinear angular dependences in (1, 2, 4).

For consideration in this paper, a BMM of the return-rotary motion is adopted, designed to work in a hand tool with the following basic dimensions and characteristics:

- magnet material is NdFeB (N33H);
- the outer diameter of the rotor-magnet is equal to 14.6 mm;
- the length of the magnet along the axis of the motor is equal to 22 mm;
- air gap length is equal to 3.5 mm;
- the outer diameter of the stator magnetic circuit is equal to 27 mm;
- frequency of mechanical oscillations of the rotor shaft is no more than 100 Hz;
- amplitude of mechanical oscillations of the rotor is no more than 30 degrees;
- maximum effective value of the stator current in continuous operation mode is equal to 0.14 A;
- the maximum temperature of the motor body is 30 ° C.

Let us further consider the possibilities and features of the experimental determination of motor parameters.

The inductance L and active resistance R of the stator winding can be determined by measurement. Since the motors under consideration are designed to operate in a limited temperature range (up to 30 ° C), there is no need to identify active resistance R during operation. Besides, the magnetic permeability of neodymium permanent magnets is close to the magnetic permeability of air, then for slotless motors with a surface installation of permanent magnets on the rotor, the value of the inductance L of the stator winding can be assumed to be a constant value. As a result of measurements, the following values of the parameters of the stator winding were established: $R = 46 \text{ Ohm}$ and $L = 0,012 \text{ Hn}$.

The moment J of rotor inertia can be calculated analytically with high precision. Without taking into account the actuating element 9 (fig. 1) on the motor shaft, we have the moment of rotor inertia: $J = 1,15 \cdot 10^{-6} \text{ kg m}^2$.

The coefficients of the motor torque k_m and elasticity k_α can be obtained from the experimental dependences of the angle α_A of deviation of the rotor shaft relative to its initial position on the external load torque M_L applied to the shaft, as well as the dependence of the same angle α_A , but only when the rotor shaft deflects by creating an electromagnetic torque M of the motor when direct current I_D flows in its stator winding. Figures 2 and 3 show the indicated experimental dependences $M_L(\alpha_A)$ and $I_D(\alpha_A)$ obtained for the motor accepted for consideration.

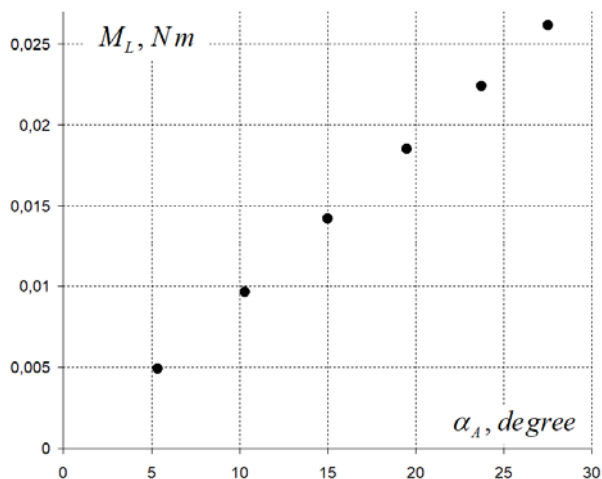

Fig. 2

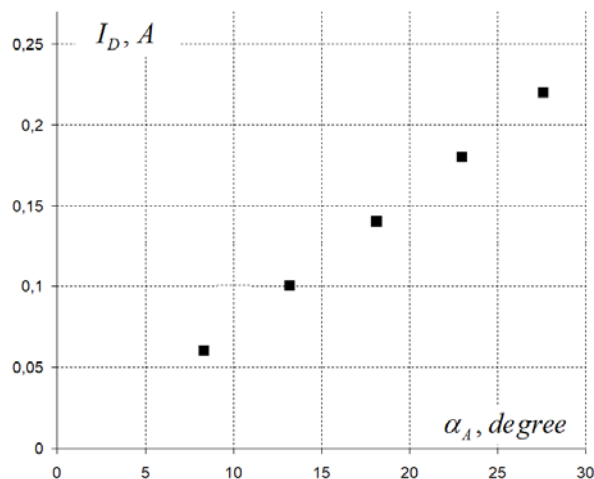

Fig. 3

Taking into account (2, 4) and the data obtained, it is possible to determine the desired constant coefficients

$$k_m = \frac{M}{I \cos \alpha_A}, \tag{11}$$

$$k_\alpha = \frac{M}{\sin \alpha_A}. \tag{12}$$

As a result of averaging the experimental data, the following results of calculating the coefficients were obtained: $k_m = 0,129 \text{ Nm/A}$ and $k_\alpha = 0,0561 \text{ Nm/rad}$.

The torque of mechanical resistance of bearings can be obtained by determining the deviation angle of the rotor shaft at which the torque of resistance of the bearings is greater than the torque created by the action of the magnetic elastic coupling between the stator and the rotor (4). In this case, you can determine such a ratio

$$M_B = k_\alpha \sin \alpha_D, \tag{13}$$

where α_D is the value of the rotor deviation angle, which limits the angular range of the indicated dead zone, equal to twice the value $2\alpha_D$. When $\alpha_D = 3 \text{ deg}$. we have the value of the torque of mechanical resistance of a pair of bearings $M_B = 2,9 \cdot 10^{-3} \text{ Nm}$.

Direct determination of the motor viscosity coefficient k_ω turns out to be difficult since it is impossible to experimentally isolate the magnitude of the viscous friction torque M_ω . The difficulty in determining the viscosity coefficient k_ω of the motor lies in the fact that losses due to eddy currents in the copper of the winding and the stator magnetic circuit arise when an alternating magnetic field appears in the core of the motor. In contrast to a traditional rotation motor, in a return-rotary motion motor, the angular speed of the rotor is a variable value that changes according to a periodic law [6]. To determine the viscous friction coefficient, it is necessary to numerically simulate the electromagnetic processes occurring in the BMM. Research in this direction is underway, and at this stage of work, the approach of an approximate indirect estimate of this parameter can be applied.

Thus, a possible method of identification seems to be the modeling of the mode of the return-rotary motion of the BMM with the previously known or experimentally determined parameters of the motor L, R, J, k_m, k_α and M_B . The unknown value of the viscosity coefficient k_ω of the motor is determined as a result of such a choice of its value, at which the same parameters of the mode of operation of the BMM are provided, as during experimental studies on a physical object. In this case, the main parameters of the mode of the return-rotary motion of the BMM, based on which it is possible to establish the correspondence of the physical and mathematically

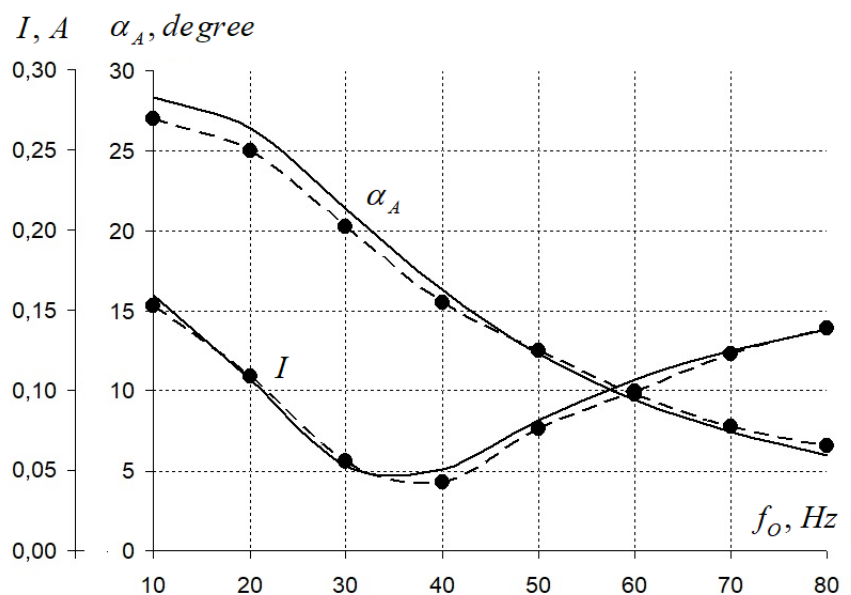

Fig. 4

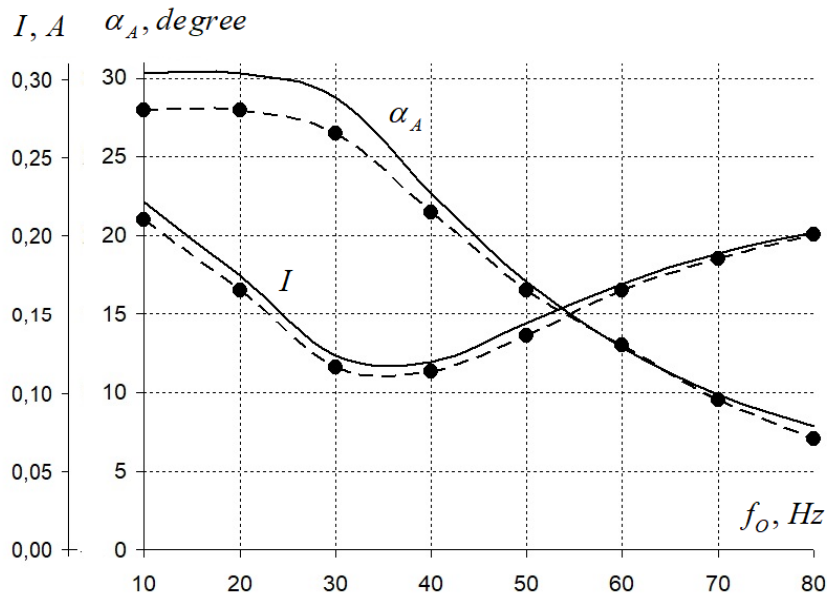

Fig. 5

simulated experiments, are the frequency f_0 of mechanical oscillations, the amplitude α_A of rotor shaft oscillations, and the effective value I of the stator current.

Next, an experiment was carried out on a physical object, in which the frequency f_0 of rotor mechanical oscillations was set in the range from 10 to 80 Hz and the values of the amplitude α_A of the rotor oscillations angle and the effective value I of the stator current were recorded, as a result of which experimental frequency dependences $\alpha_A(f_0)$ and $I(f_0)$ were obtained. Then, as a result of calculations based on the model (1–8), by varying the value of the viscous friction coefficient k_ω , it was established such its value at which the average error of the experimental and calculated frequency characteristics was no more than 9 %. Thus, such a value of the coefficient was obtained: $k_\omega = 5,5 \cdot 10^{-5} \text{ Nms/rad}$. The experimental and calculated frequency characteristics are shown in fig. 4 and 5, respectively, for two variants of the formation of the alternating stator voltage: sinusoidal (9) and rectangular (10). The amplitude U_A of the stator alternating voltage was assumed to be constant and equal to 12 V. The solid lines show the calculated characteristics, while the dashed lines show the experimental.

Besides, to demonstrate the adequacy of the adopted model (1–8) of the motor of the return-rotational motion, as well as to confirm the correctness of the experimental determination of its parameters, fig. 6 and 7 show the calculated curves and experimental oscillograms of alternating currents i and stator voltages u for sinusoidal (fig. 6) and rectangular (fig. 7) voltage options. Oscillograms were obtained at two frequency values of 10 Hz (fig. 6 *a*, fig. 7, *a*) and 40 Hz (fig. 6, *b*, fig. 7, *b*). Comparison of the calculated curves and experimental oscillograms shows their good correspondence.

The considered motor of the return-rotary motion is characterized by parameters that can be assumed to be unchanged during operation. However, if an actuating element with its moment of inertia is installed on the motor shaft, the total moment of inertia of the rotor with the load turns out to be unknown. In this case, to determine the changed total moment of inertia, an algorithm for its identification can be applied by the short-time supply of a reference variable input signal of the type $u = U_A \sin 2\pi f_0 t$ to the stator winding and fixing a new value of the amplitude of the rotor oscillations angle. The frequency value for such signal should be selected from the low-frequency part of

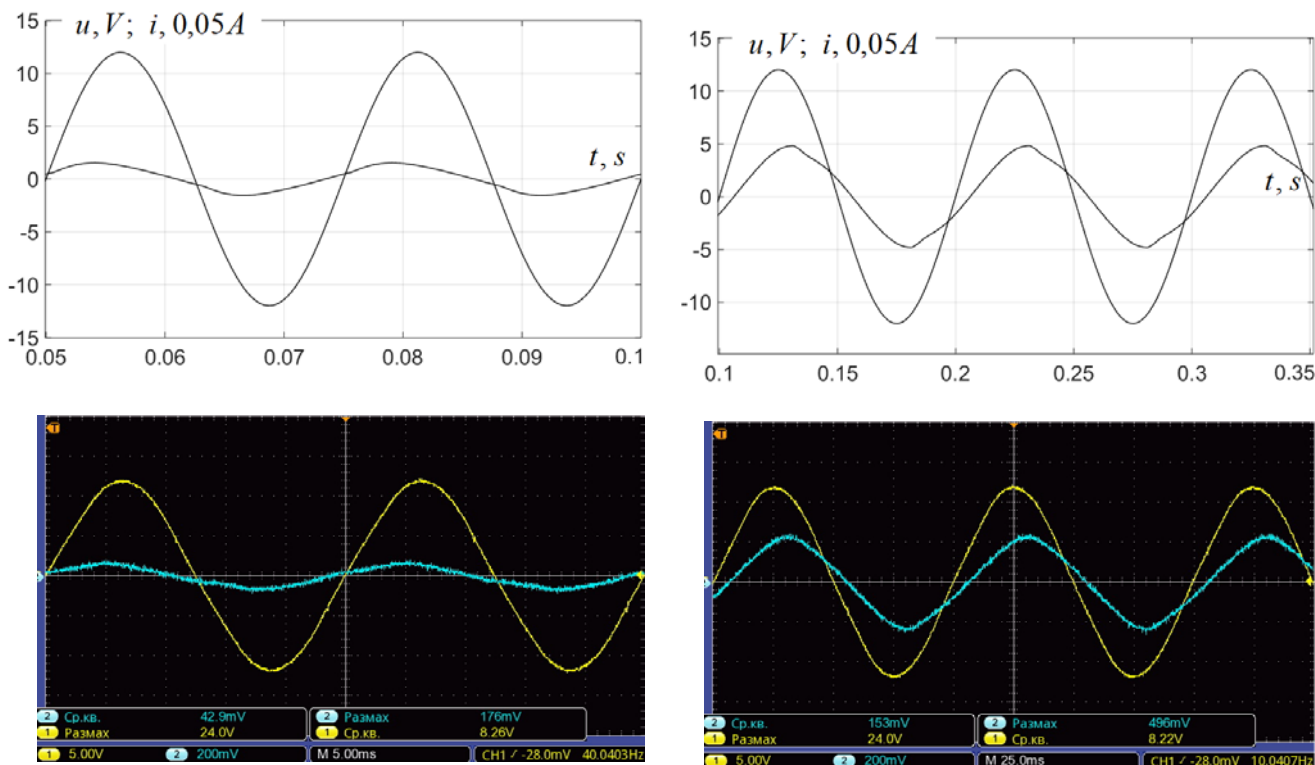

a

Fig. 6

b

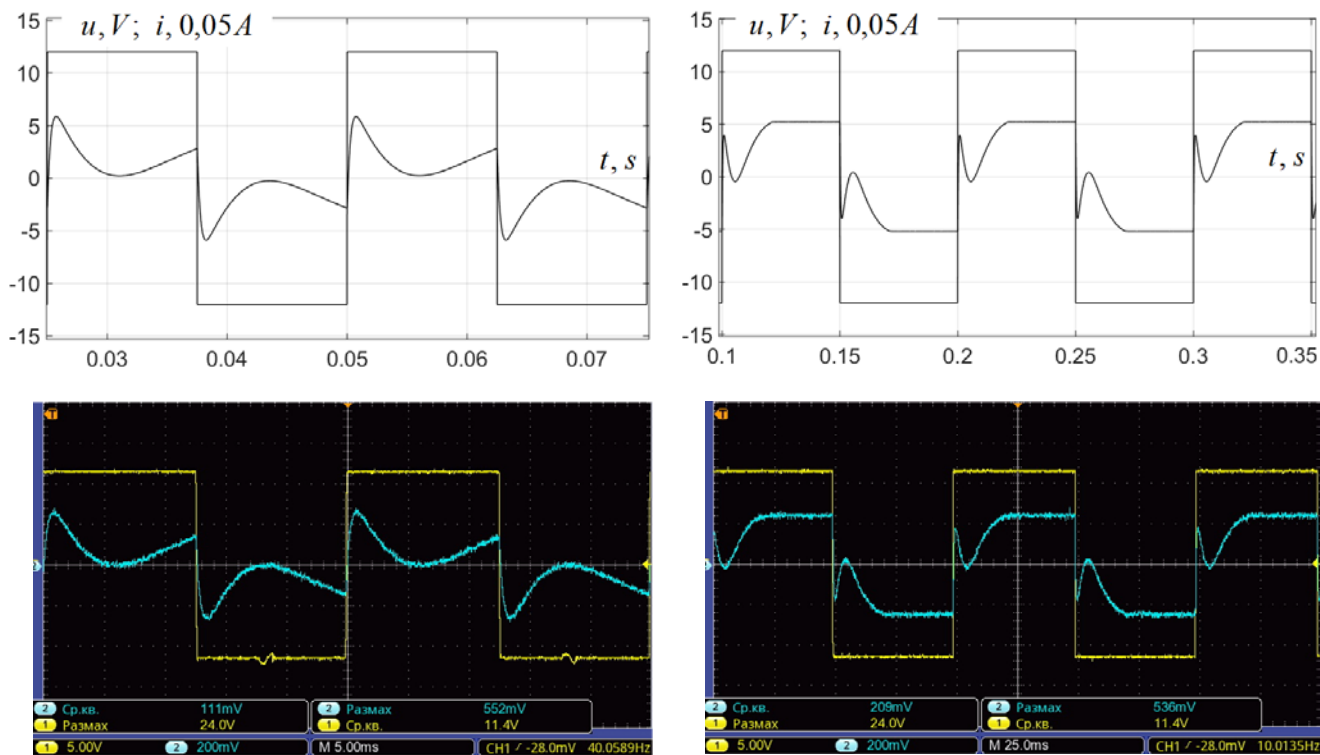

a

Fig. 7

b

the operating range, for example, $f_0 = 10, Hz$. The signal amplitude is chosen so that the amplitude of the rotor oscillations angle in the assumed range of possible values of the moment of inertia does not exceed 20-25 degrees. For the maximum value of the moment of inertia $J = 9,2 \cdot 10^{-6} kg m^2$, we assume $U_A = 5V$.

Fig. 8 shows the calculated dependence of the amplitude α_A of the rotor oscillations angle on the value of the moment J of inertia on the motor shaft. Thus, the sought dependence for an approximate determination of the moment of inertia can be represented by the expression

$$J = \frac{J_1 - J_0}{\alpha_{A1} - \alpha_{A0}} (\alpha_A - \alpha_{A0}) + J_0, \quad (14)$$

where J_0 , J_1 are the values of the moment of inertia on the rotor shaft without an actuating element, as well as one of the selected values from the characteristic $\alpha_A(J)$ (fig. 8), α_{A0} , α_{A1} are the values of the amplitude of the rotor oscillations angle corresponding to the values J_0 and J_1 .

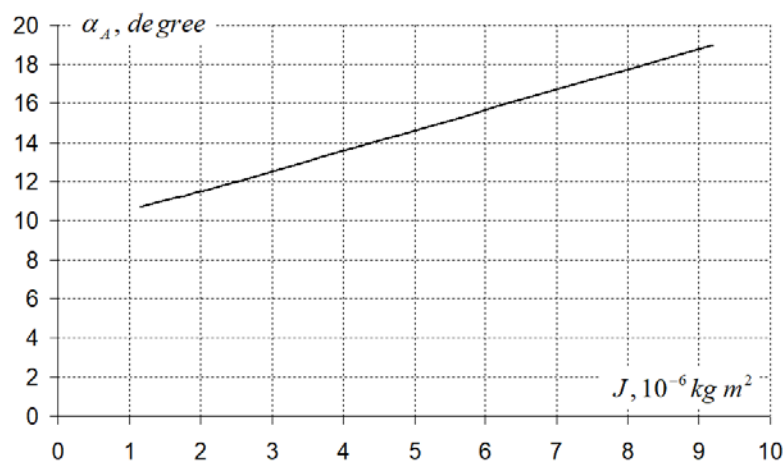

Fig. 8

For substitution in (14), the following values of the parameters were taken: $J_0 = 1,15 \cdot 10^{-6} \text{ kg m}^2$, $J_1 = 4,6 \cdot 10^{-6} \text{ kg m}^2$, $\alpha_{A0} = 10,7 \text{ deg.}$ and $\alpha_{A1} = 14,2 \text{ deg.}$ In this case, for a given for example the maximum value of the amplitude $\alpha_A = 18,98 \text{ deg.}$ of the rotor shaft oscillations angle, the value of the moment of inertia is determined with an error equal to 1.21%. The need to determine the unknown value of the moment of inertia on the motor shaft may arise in the case of the implementation of the mode of active compensation of reactive sign-alternating moments of the return-rotary motion motor rotor [7].

Conclusion. As a result of the studies, the adequacy of the adopted mathematical model (1-8), describing the BMM of the return-rotary motion, was confirmed. Also, on its basis, with experimentally determined parameters, it is possible to calculate any operating mode of the investigated BMM and synthesize systems for automatic control of the return-rotary motion of the rotor.

Фінансується за держбюджетною темою «Створити методи активної компенсації реактивних зусиль, моментів та просторових переміщень в електромеханічних системах магнітоелектричного типу та розробити принципи побудови пристроїв на їх основі» (шифр «ІНДЕМ»), що виконується за Постановою Бюро ВФТПЕ 15.10.2013 р., протокол № 14. Державний реєстраційний номер роботи 0113U006532. КПКВК 6541030.

1. Smeliahin A.Y. The structure of mechanisms and machines. Moskva: Vysshaya shk., 2006. 304 p. (Rus)
2. Yusoff A.S., Che-Ani A.I., Hussain Z., Hmzah N., Boudvill R., Rahman M.F.A. Back-Drivability of Powered Knee Free Swing and Knee Extension. *7th IEEE International Conference on Control System, Computing and Engineering (ICCSCE 2017)*. 24-26 November 2017. Penang. Malaysia. Pp. 331–335. DOI: <https://doi.org/10.1109/ICCSCE.2017.8284429>
3. Lukovnikov V.Y. Electric drive of oscillatory motion. Moskva: Ener-goatomizdat, 1984. 152 p. (Rus)
4. Zahrivnyi E.A., Havrilov Yu.A. The method of excitation and regulation of autoresonance oscillation in the electric drive of the return-rotary motion. Patent RF No 2410826. 2009. (Rus)
5. Antonov A.E., Kireyev V.G. Massage device. Patent UA 74668. 2006. (Ukr)
6. Akinin K.P., Kireyev V.G., Filomenko A.A., Lavrinenko B.A., Mikhailik E.M. Research of electromechanical characteristics of brushless magnetolectric motors of return-rotary motion. *Pratsi Instytutu elektrodynamiky NAN Ukrainy*. 2019. No 54. Pp. 47–51. (Rus)
7. Antonov A.E., Akinin K.P., Kireyev V.G., Filomenko A.A. Compensation of reactive torques in the electric drive of the return-rotary motion. *Pratsi Instytutu elektrodynamiky NAN Ukrainy*. 2018. No 51. Pp. 54–60. (Rus)

ЕКСПЕРИМЕНТАЛЬНІ ДОСЛІДЖЕННЯ БЕЗКОНТАКТНИХ МАГНІТО-ЕЛЕКТРИЧНИХ ДВИГУНІВ ЗВОРОТНО-ОБЕРТАЛЬНОГО РУХУ

В.Г. Кіреєв, канд. техн. наук, **К.П. Акінін**, докт. техн. наук, **А.А. Філоменко**, **В.А. Лавріненко**

Ін-т електродинаміки НАН України,
пр. Перемоги, 56, Київ, 03057, Україна
e-mail: kyg2016@ukr.net

У статті описано структуру та математичну модель спеціалізованого безконтактного магнітоелектричного двигуна зворотно-обертального руху. Проведено аналіз параметрів математичної моделі та описано способи їх експериментального визначення. Отримано експериментальні частотні залежності амплітуди кута механічних коливань ротора і діючого значення струму статора. На підставі отриманих параметрів виконано розрахунок частотних характеристик двигуна та проведено їх порівняння з експериментальними залежностями. Представлено експериментальні осцилограми та розрахункові криві напруг і струмів статора. Бібл. 7, рис. 8.

Ключові слова: безконтактний магнітоелектричний двигун, зворотно-обертальний рух, частотна характеристика, експериментальні дослідження.

Received: 08.04.2021
Надійшла: 08.04.2021