

UDC 628.85

## CHOOSING A UNIVERSAL AIR COLLECTOR DESIGN FOR A CYLINDRICAL-SHAPED HOT-WIRE ANEMOMETER

**Oleh S. Tsakanian**[tsakoleg@rambler.ru](mailto:tsakoleg@rambler.ru)

ORCID: 0000-0002-1077-9818

**Serhii V. Koshel**[koshel@nas.gov.ua](mailto:koshel@nas.gov.ua)

ORCID: 0000-0003-3603-0909

A. Pidhornyi Institute of Mechanical Engineering Problems of NASU  
2/10, Pozharskyi St., Kharkiv, 61046, Ukraine

*Air flow measurement at the outlets of air terminal devices installed in ventilation systems is very difficult. At the outlets of anemostats, swirl diffusers, grilles, the air flow can swirl, contract, or expand sharply, change its direction, etc., which causes great measurement errors. Therefore, it was necessary to develop a universal measuring device that would make it possible to measure air flow rate with high accuracy. It should consist of an air collector (for collecting and rectifying air flow) and a sensor for measuring air flow rate (integral hot-wire anemometer). Several air collector designs have been investigated. The parabolic air collector was chosen as the rational one. It has low aerodynamic resistance and good air flow distribution. To reduce the influence of turbulence and air swirling, a cylindrical stilling channel with a built-in rectifying grille is connected to the air collector. Experimental studies on various air distribution devices made it possible to obtain a refined calibration dependence for an integral hot-wire anemometer, the dependence being used to calculate air flow rate. The influence of the aerodynamic resistance of an airflow meter on air flow rate is taken into account with the help of a correction that must be introduced into the values measured.*

**Keywords:** air collector, hot-wire anemometer, measurements.

### Introduction

Adjustment of combined inlet-and-exhaust ventilation systems requires that the air flow rate be measured at the outlets or inlets of anemostats, diffusers, and ventilation grilles. In this case, the directions of the air flow can be different. For example, at the outlet of the inlet anemostat [1], the air enters the room through a concentric slot, spreading along the ceiling, and at the outlet of the rectangular grille, it jets towards the floor. This difference in flows significantly complicates the measuring process, since the air must first be collected in a single channel, and then directed to the probe of the measuring device. In this case, such a matching device, or, in other words, an air collector, must have a minimum aerodynamic resistance in order to prevent the air flow rate from dropping on elements of inlet-and-exhaust ventilation systems. Another requirement for an air collector is the absence of reverse flows and turbulence at its outlet, since they can introduce a significant error in the measurement of the air flow rate. The development of such a universal device would significantly simplify the measurement process and improve the accuracy of air flow rate measurements [2].

In its catalog, Testo, a well-known manufacturer of measuring equipment [3] presented the testo417 kit, which serves precisely for the purposes indicated, and includes an air flow rectifier with a diameter of 100 mm and two transition funnels – a round funnel with a diameter of 200 mm and a square one with a size of 330×330 mm. The manufacturer does not specify the dependence of the aerodynamic resistance of the air flow rectifier and funnels on the air flow rate. Here, measurements are carried out using the testo417 instrument, which includes a 100 mm impeller, significantly limiting the scope of its application, since in all elements of the ventilation system with an area larger  $(\pi \cdot 0.1^2)/4 = 0.00785 \text{ m}^2$ , the actual air flow rate can be reduced by narrowing the channel.

There are other instruments used to measure air velocity or air flow rate. Most of them are single point ones, that is, they allow a one-time measurement of a physical quantity at one section point. Such devices include a differential pressure gauge with a probe in the form of a Pitot tube [4], hot-wire anemometers [5] with a heated wire [6] or thermal film [7]. The aforementioned vane anemometers have integrating properties, however, when measuring the air velocity in channels whose diameters are comparable to that of the impeller, errors associated with a change in the air flow rate due to the blockage of the channel are possible. In [8], an assessment of the accuracy of point measurements in ventilation systems is given. It is shown that

This work is licensed under a Creative Commons Attribution 4.0 International License.

© Oleh S. Tsakanian, Serhii V. Koshel, 2021

it is impossible to take into account all the factors affecting the error, which is why, when commissioning and certifying ventilation systems, it is necessary to include an error of at least 20%.

It is possible to reduce the measurement error if one uses not point, but integral sensors, which enable to simultaneously measure the average air flow rate over the air duct section. The principle of operation of such hot-wire anemometers [9] is based on the dependence of the heat transfer from the sensing element on the air velocity. Due to the uniform arrangement of the sensing element over the channel cross-section, such devices are practically insensitive to changes in the velocity profile. However, the presence of strong turbulence, for example, at anemostat outlets, can adversely affect the measurement accuracy. To avoid this, it is necessary to install a transitional air collector upstream of the integral hot-wire anemometer, which will smooth the air flow. Such an air collector must have the circular cross-section of an anemostat. At the same time, the air collector shape can be different. This article is devoted to the choice of the rational design of the air collector, downstream of which a measuring device can be installed. The initial shape selection was carried out using computer simulation, and the results were confirmed experimentally.

**Determination of the Correctness of the Chosen Computer Model**

The method for choosing the shape of the air collector is based on the visual observation of the air flow structure at its outlet, where a measuring device is installed. When choosing the shape, priority was given to structures that had neither reversing flows nor swirls and turbulences. After choosing the shape, preference was given to the air collector with the minimum aerodynamic resistance and smallest design height along its axis for the convenience of measurements.

The shape of the air collector influences the structure of the air flow as well as its own aerodynamic resistance. To determine its value, there was studied the indoor steady-state air movement process whose model is shown in Fig. 1. For this, two aerodynamic problems were solved with the same initial data (air flow rate and room geometry). In the first problem, the air entered an empty room through the inlet anemostat and left the room through the exhaust outlet. In the second problem, an air collector and an integral hot-wire anemometer probe were connected to the inlet anemostat.

The aerodynamic resistance of an air collector can be considered as the difference  $\Delta P = P_2 - P_1$  between the static pressure drop  $P_2$ , which is the result of solving the second problem, and the static pressure drop  $P_1$  obtained as a result of solving the first problem ( $P_1$  and  $P_2$  are the static pressure drops between the anemostat outlet and the exhaust inlet).

Before proceeding with the study of air collector structures via computer-aided simulation, it was necessary to make sure that the chosen model was correct.

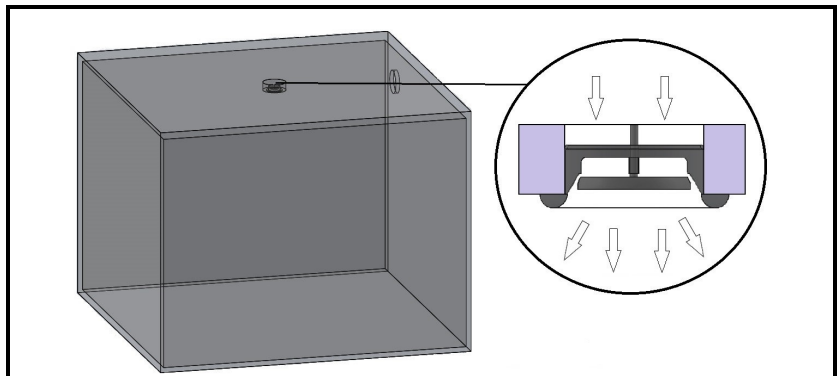

*Fig. 1. A sketch of the room with an anemostat installed in its upper part*

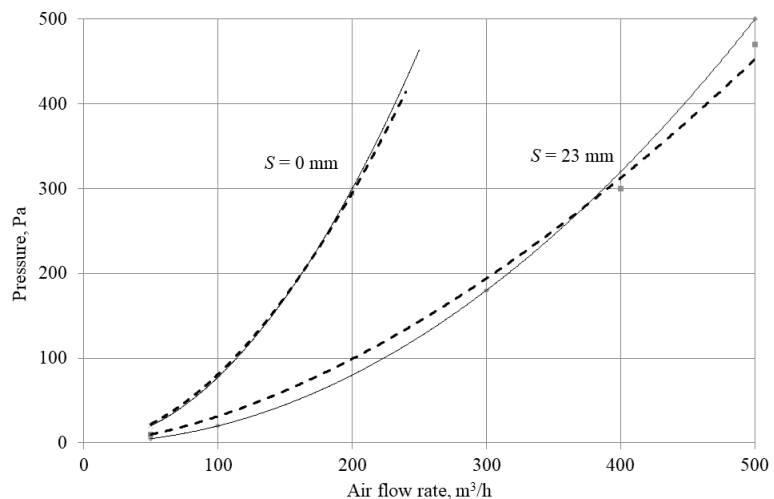

*Fig. 2. Comparison of the computational and experimental aerodynamic resistances of a 150 mm diameter inlet anemostat*

In [1], technical characteristics of anemostats are given – the aerodynamic resistance dependencies on the air flow rate. These dependencies were used as a basis for comparison with the computer simulation results in order to quantify the reliability of the studies carried out for a steady air movement in a room with an anemostat installed in the air inlet (see Fig. 1). The difference between static pressure drops relative to the inlet and outlet is the aerodynamic resistance of the anemostat together with the resistance of the room. Due to the low aerodynamic resistance of the room, it can be neglected. The reliability of the calculations performed using a computer model was assessed by comparing them with the technical characteristics of the anemostat.

In Fig. 2, the solid curves denote the computational resistance dependencies on the air flow rate for two valve positions of a 150 mm diameter anemostat at a valve stroke of  $S=10$  and 23 mm, the dashed curves refer to the resistances taken from the anemostat product catalog [1]. Having compared the aerodynamic resistance, one can conclude that the computational model gives the results that are comparable with the physical measurements, and one can assume that it can be used for research.

### Overview of Anemostat Designs

The resistance of an anemostat depends on its design. There are three types of anemostat design [1]: exhaust, inlet, and inlet-and-exhaust. Structurally, their difference lies in the form of the poppet valve. In an exhaust anemostat, the valve has a convex shape towards the room, in an inlet anemostat, the valve has a concave shape, and in an inlet-and-exhaust one, the valve has a flat shape.

In the initial state, when the control valve travels along the axis  $S=0$  mm, the width of the concentric slot between the diffuser and valve is 4–5 mm. This ensures the removal of air from the room in a minimum volume. By changing the position of the valve, the flow rate of the air drawn from the room can be controlled. If an exhaust anemostat is used as an inlet one, then a conical stream will flow out of it, providing the desired air mixing.

An inlet anemostat forms a jet around itself trailing along the ceiling surface. Initially, the valve protrudes from the diffuser. The trailing jet ensures an even distribution of the air temperature over a large area around the anemostat, which ensures that there are no drafts in the room.

An inlet-and-exhaust anemostat, depending on the position of the valve, can form a jet with a variable geometry: from conical to trailing.

The described jet flow patterns form various flow structures in a room. Connecting an air collector with a measuring device to the anemostat changes the flow structure, converting it to the jet hitting the floor or other obstacle, spreading in all directions with the subsequent formation of circulations in the volume limited by the walls of the room. A similar flow pattern is observed when the air flow rate is measured in inlet anemostats. The flow pattern difference inside the room should affect the aerodynamic resistance of both air collectors and anemostats.

Therefore, it was necessary to conduct studies to determine the effect of an air collector on the accuracy of measuring the air flow rate, and to obtain a quantitative assessment of the aerodynamic characteristics of the air collector.

Since the air flow structures, depending on the air collector design, will differ from each other, one should expect the air collector to have different aerodynamic resistances whose value was estimated using computer simulation. In order to limit the volume of information provided on the research being conducted, the geometric shape of the air collector was first chosen, and then the aerodynamic resistances of various anemostat designs were determined for it.

### Choosing the Air Collector Design

Initially, several air collector designs were chosen, differing both in the shape of the channel and in geometry. The study of aerodynamic resistances and the distribution of velocities at the outlet of the matching device made it possible to choose the following design: the air collector has the shape of a funnel with a stilling channel at whose outlet the probe of the measuring device is located.

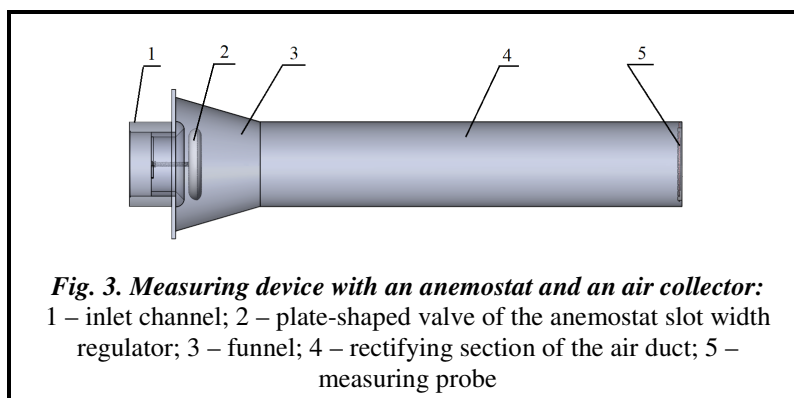

**Fig. 3. Measuring device with an anemostat and an air collector:**  
1 – inlet channel; 2 – plate-shaped valve of the anemostat slot width regulator; 3 – funnel; 4 – rectifying section of the air duct; 5 – measuring probe

When choosing the size of the air collector, the fact that it should not affect the air flow rate was taken into account, i.e. its aerodynamic resistance should be as low as possible. To fulfill this condition, the area of any cross-section of the air collector must be greater than that of the anemostat slot through which the air passes. For round anemostats, the area of the slot width varies from 0.002 to 0.008 m<sup>2</sup>. In this case, the minimum diameter of the air collector should be at least 0.16 m, and the diameter of 0.2 m can be used with some margin to increase the measurement accuracy. It turns out that one funnel suits the entire range of anemostat diameters from 80 to 200 mm.

Fig. 3 schematically shows a measuring device. The formation of the jet direction and speed depends on the geometry of the surfaces of the channel and the anemostat control valve, which forms a slot whose width changes with the movement of the valve.

Initial data for rationalizing the air collector design:

- room dimensions – 4×4×3 m<sup>3</sup> (48 m<sup>3</sup>);
- diameter of the inlet where the anemostat is installed, – 80, 100, 125, 150, 200 mm;
- diameter of the exhaust outlet – 300 mm;
- diameters of the conical funnel – 300 and 200 mm;
- height of the cone-shaped funnel – 200 mm;
- wall thickness of the funnel and cylinder – 2 mm;
- maximum area of the anemostat slot – 0.008 m<sup>2</sup>.

With the help of computer simulation, air flow trajectories were built when the air passed the measuring section in the probe location area. The study of the flow pattern in the conical air collector and a 1 m long cylinder attached to the narrow part of the truncated cone showed that with an increase in the air flow rate downstream of the anemostat control valve, a swirl zone is formed (Fig. 4). This is typical for a small gap between the valve and the anemostat housing (no more than 5 mm). The intensity of swirls increases the length of the downstream wake. The nature of the aerodynamic flow is not rectilinear, since there is a reverse flow in the corners along the wall, the flow propagating practically along the entire length of the cylinder. With increasing gap, the number of swirls decreases, and swirls are no longer observed at a gap of about 25 mm (Fig. 5).

Several studies of the air flow structure have been carried out for 80–200 mm-diameter inlet anemostats at an air flow rate of 100–500 m<sup>3</sup>/h. As a result, it was concluded that the conical shape of the air collector does not meet the requirements for the flow structure.

To eliminate circulations and reversing flows in the flow path of the probe, the shape of the air collector was changed. Instead of the truncated cone, a truncated paraboloid with a 200 mm inlet diameter was taken, first narrowing to a diameter of 150 mm, and then expanding to a diameter of 200 mm (Fig. 6).



*Fig. 4. Velocity fields through the anemostat, funnel and part of the cylinder for a 5 mm gap*

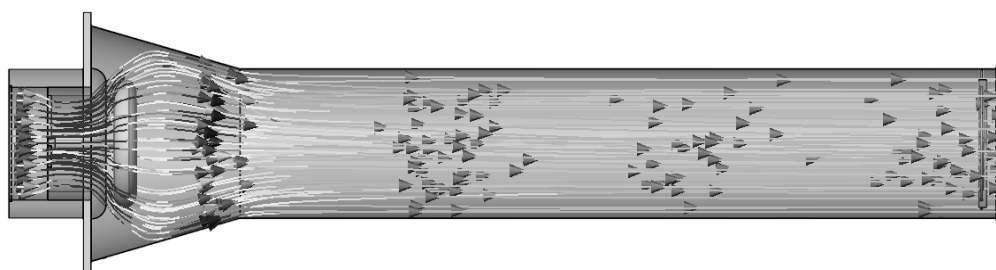

*Fig. 5. Velocity fields through the anemostat, funnel and part of the cylinder for a 25 mm gap*

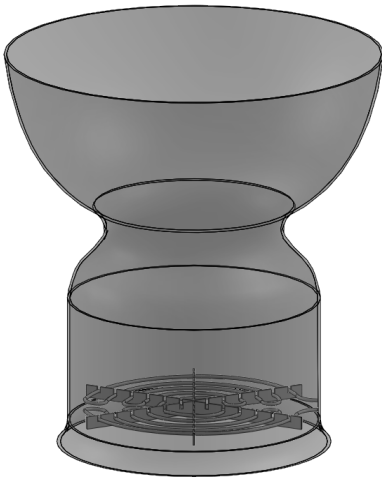

**Fig. 6. Parabolic air collector with a measuring probe at the bottom**

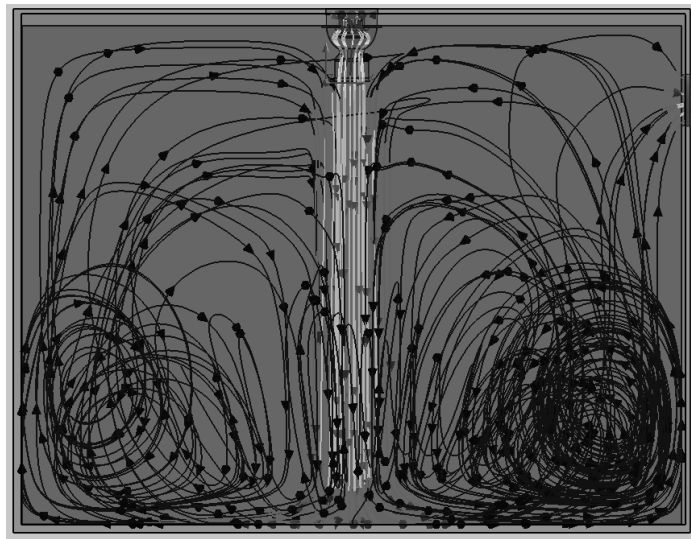
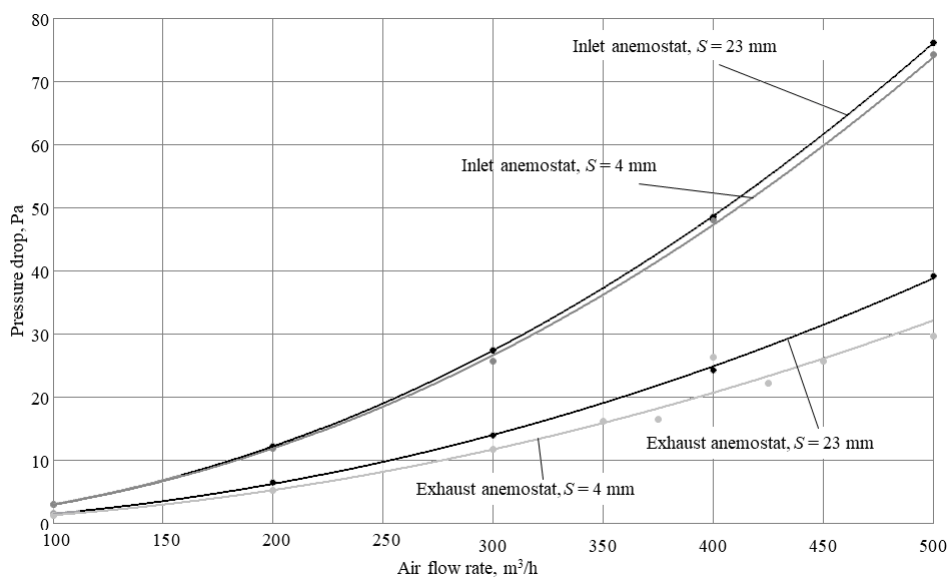

**Fig. 7. Trajectories of the air flow through a parabolic air collector installed on an 150 mm-diameter anemostat in a room**

Computer simulation showed that behind such an air collector connected to a 150 mm-diameter inlet anemostat and installed in a room, the air flows do not form swirling zones and reversing flows (Fig. 7). Moreover, this picture is observed for the entire range of the anemostat control valve opening (5–23 mm). This means that a measuring device can be safely installed at the air collector outlet.

**Determination of the Resistance of a Parabolic Air Collector**

Since the existing inlet air collectors differ from each other in channel diameter, and are geometrically similar structures, it should be assumed that the air jets at their outlets will be geometrically similar. Thus, it can be assumed that the patterns of the air flows in the flow channel of an air collector will be identical. This means that the dependencies of the aerodynamic resistance of an air collector on the air flow rate for the entire series of anemostats will be practically the same, and this study can be carried out for one anemostat having a channel diameter, for example, of 150 mm. The results obtained can be extended to all the standard sizes of anemostats.



**Fig. 8. Comparison of the aerodynamic resistances of the air collector when measuring the air flow rate at the outlet of the inlet anemostat and inlet of the exhaust one for the valve stroke S=4 and 23 mm**

The resistance of an air collector is weakly dependent on the stroke of the control valve, as can be seen in figure 8. The maximum resistance of a parabolic air collector, when measuring the air flow rate at the inlet anemostat for the flow rate of 500 m<sup>3</sup>/h and the valve stroke  $S=23$  mm is 76 Pa, and at the exhaust one, for the same flow rate, about 40 Pa. Such an almost twofold difference in aerodynamic resistance is caused by a different air movement direction and a different flow pattern. In the exhaust anemostat, a smoother flow is observed at a lower velocity due to the expansion of the flow and a wider gap between the surfaces of the channel and valve.

The approximation of resistance dependencies on air flow rate makes it possible to obtain a correction for practically any measurement conditions on ventilation grilles and anemostats, which enables to increase the measurement accuracy.

### Experimental Studies of the Characteristics of an Airflow Meter Based on a Parabolic Air Collector

The results of the performed mathematical modeling were verified using experimental measurements. The criterion for assessing the correctness of the measurement results for various designs of air distribution devices was small deviations from the main calibration characteristic of the integral hot-wire anemometer probe, the characteristic having been obtained under conditions of a uniformly distributed direct air flow [9].

The airflow meter characteristics were measured on a test stand, which is an open wind tunnel presented schematically in figure 9.

The aerodynamic characteristics of the test stand and airflow meter were measured in three sections using pressure receivers.

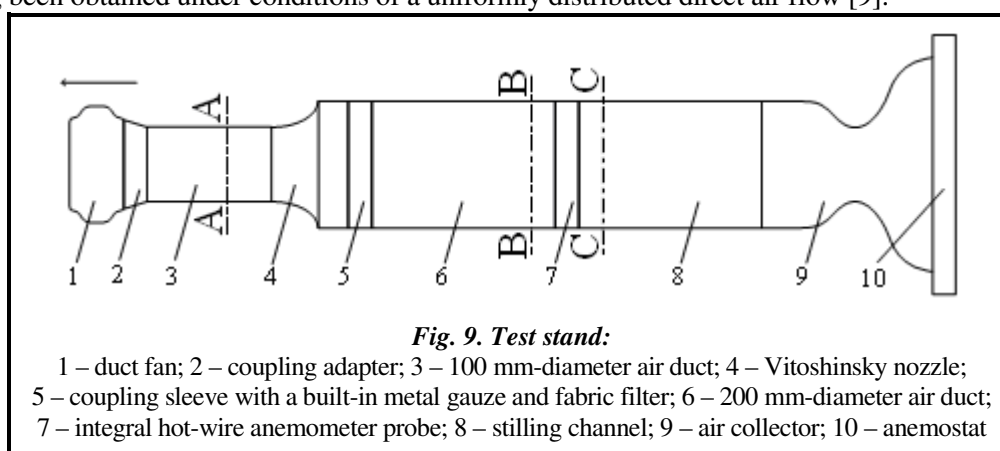

**Fig. 9. Test stand:**

1 – duct fan; 2 – coupling adapter; 3 – 100 mm-diameter air duct; 4 – Vitoshinsky nozzle; 5 – coupling sleeve with a built-in metal gauze and fabric filter; 6 – 200 mm-diameter air duct; 7 – integral hot-wire anemometer probe; 8 – stilling channel; 9 – air collector; 10 – anemostat

Measurement section "A–A" is intended to measure the air velocity at the outlet of the Vitoshinsky nozzle installed in the air path in front of the duct fan inlet. Measurement section "B–B" is used to measure the aerodynamic characteristics of the test stand. Measurement section "B–B" allows measuring the aerodynamic resistance of an air collector. The air flow measurements were carried out with an integral hot-wire anemometer probe [9] at the outlets of various diffuser designs, as well as anemostats with one and two control valves.

A parabolic air collector has an attached stilling channel with a length equal to 0.5 of its diameter. At the outlet is installed an integral hot-wire anemometer probe. The studies were carried out for an 150 mm-diameter anemostat with a poppet-shaped valve with whose help the air flow rate was controlled. The experimental studies have confirmed that changes in the valve stroke do not lead to significant deviations from the main calibration characteristic. For anemostats with other geometric standard sizes, the calibration characteristics differed from the main one up to 30%, depending on the valve stroke and anemostat diameter. The reason for the deviations is the downstream-of-the-valve swirls, which hit the sensing element of the integral hot-wire anemometer probe. The length of the stilling channel was insufficient to rectify the flow. By increasing the length of the channel to two of its diameters, it was possible to achieve the coincidence of the calibration characteristics (Fig. 10).

The resulting refined calibration characteristic is approximated by two dependencies:

$$\text{Nu}=0.331 \cdot \text{Re}^{0.5306,0} < \text{Re} < 1000; \quad \text{Nu}=0.1507 \cdot \text{Re}^{0.6464}, \quad 1000 \leq \text{Re} \leq 2000,$$

where Nu is the Nusselt number; Re is the Reynolds number.

This calibration characteristic can be used to measure the air flow rate using an integral hot-wire anemometer at the outlets of anemostats of any standard size and design.

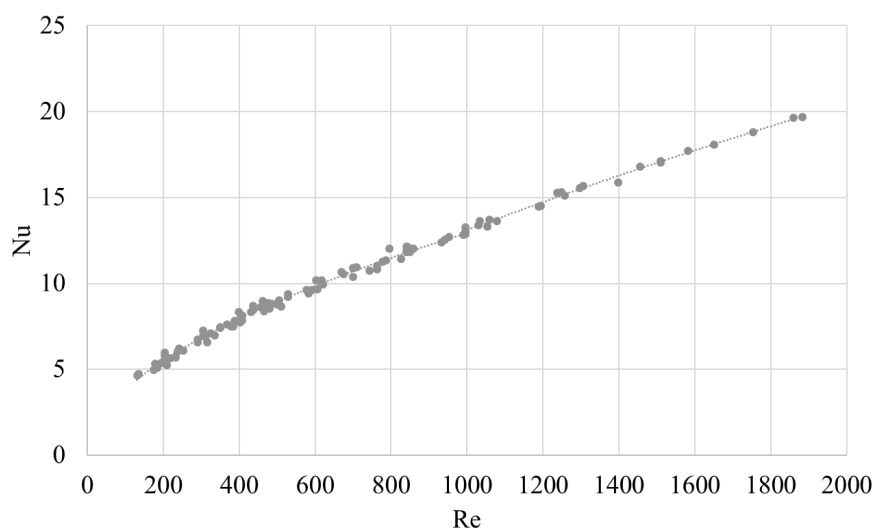

*Fig. 10. Calibration characteristic of the integral hot-wire anemometer probe with an air collector consisting of a parabolic air collector and a stilling channel with a length of 400 mm long and diameter of 200 mm*

### Using a Parabolic Air Collector to Measure the Rate of the Air Flow Swirled by an Axial Fan or Swirl Diffuser

If it is required to measure the air flow rate at the outlet of a swirl diffuser or a fan, rather than an anemostat, the above dependencies cannot be applied, since the air flow swirl downstream of these devices strongly affects the change in heat transfer from the integral hot-wire anemometer. Therefore, the design of such an airflow meter was improved – a grille was needed that would rectify the swirling air flow. For this purpose, a rectifying grille, consisting of eight 360 mm long, 98 mm high, 1.5 mm thick, and 45-degree-angle spaced plates was installed in the 400 mm long and 200 mm-diameter channel (Fig. 11).

The experimental measurements of the air flow rates at the outlets of various swirl-forming devices have confirmed their almost complete agreement with the main calibration characteristic (Fig. 12). As passive swirling devices a VD400 swirl diffuser with a diameter of 400 mm and an axial fan impeller with a diameter of 300 mm, mounted motionlessly in a cylindrical channel with a diameter of 300 mm, were used.

Dependence 1 in figure 12 was obtained by measuring the air flow rate at the outlet of the VD400 swirl diffuser in the absence of a rectifying grille. Dependence 2 was obtained by measuring the air flow rate downstream of the EBMPAPST DV6224 DC axial fan with a 143 mm-diameter impeller. Dependence 3 was obtained by measuring the rate of the air flows swirled by passive air distribution devices. As one can see, the absence of a rectifying grille leads to an error of up to 30%.

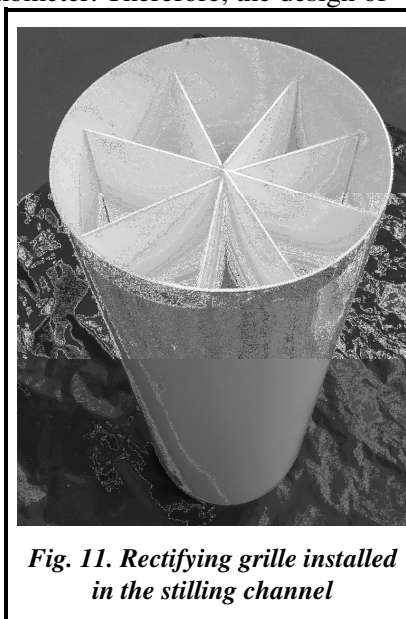

*Fig. 11. Rectifying grille installed in the stilling channel*

### Measurement of the Aerodynamic Resistance of an Airflow Meter Based on a Parabolic Air Collector with a Stilling Channel, Rectifying Grille, and an Integral Hot-wire Anemometer Probe

The aerodynamic resistance measurements were carried out when the air entered the room through the parabolic air collector, stilling channel with a rectifying grille, and the integral hot-wire anemometer probe. The final results of measuring the aerodynamic resistances of the above structural elements are shown in Fig. 13.

In figure 13, dependence 1 takes into account all the elements of the airflow meter design. The highest resistance is possessed by the air collector represented by dependence 3. The smallest ones, by the probe (dependence 3) and the rectifying grille (dependence 4) whose aerodynamic resistance can be represented as the difference between dependencies 1 and 2. Thus, the presence of the air collector has little effect on the air

flow rate measurement results. This influence can be taken into account by means of a correction calculated by the formula:

$$\Delta G_v = 0.0274 \cdot G_v^{1.2106}, \quad 0 < G_v < 600 \text{ m}^3/\text{h},$$

where  $G_v$  is the measured air flow rate.

The resulting correction must be subtracted from the air flow rate measured with the airflow meter and integral hot-wire anemometer.

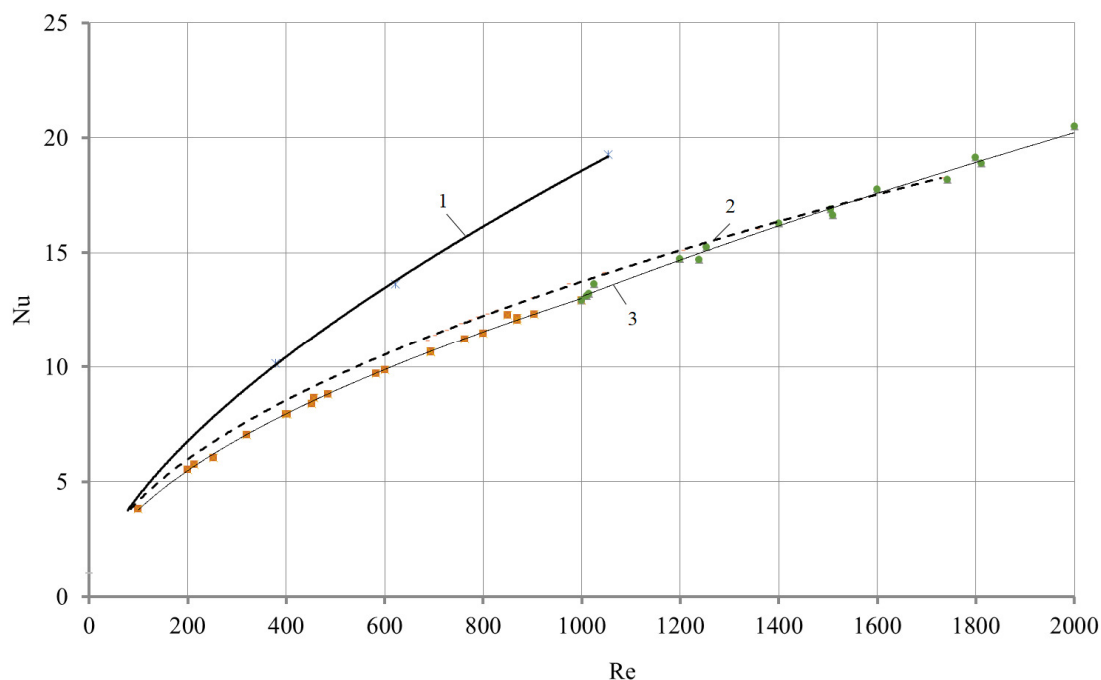

Fig. 12. Calibration characteristics of the integral hot-wire anemometer probe downstream of the swirl diffuser and the axial fan

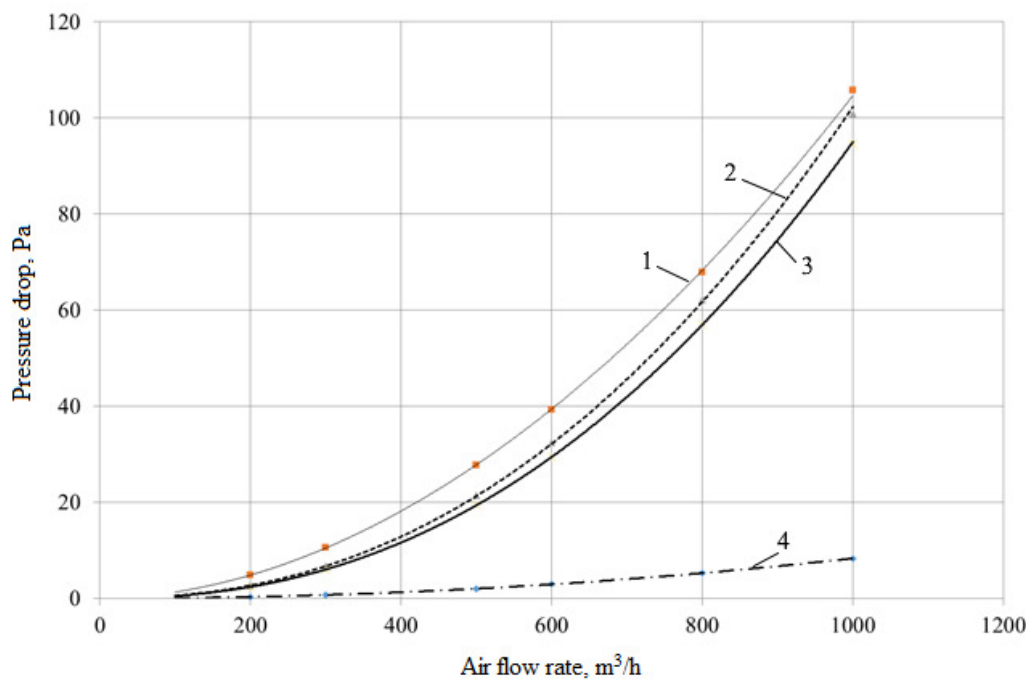

Fig. 13. Aerodynamic resistance dependencies on the air flow rate for the airflow meter including a parabolic air collector, stilling channel with a built-in rectifying grille, and a hot-wire anemometer probe



## Conclusion

Taking into account the research results, it can be concluded that the design of the parabolic air collector, the dimensions of the air flow rectifier, and the stilling channel have been chosen correctly, and the airflow meter itself has versatility, and allows measuring the air flow rate at the inlets and outlets of almost any air distribution device in ventilation systems. To measure the air flow rates at the outlets of large-diameter swirl diffusers, it is possible to use large-sized airflow meter designs with a similar geometry. The correction must be taken into account to refine the air flow rate measurement results.

## Financing

The work was carried out at the expense of the budget program "Support for the development of priority areas of scientific research" (КРКVK 6541230).

## References

1. (2013). *Vozdukhoraspredelitelnyye ustroystva* [Air distribution devices]: Catalog. VENTS: Official site. Kyiv, 101 p. (in Russian). URL: [https://js.com.ua/upload/iblock/311/15\\_1156\\_cat\\_file.pdf](https://js.com.ua/upload/iblock/311/15_1156_cat_file.pdf).
2. O'Sullivan, J., Ferrua, M., Love, R., Verboven, P., Nicolai, B., & East, A. (2014). Airflow measurement techniques for the improvement of forced-air cooling, refrigeration and drying operations. *Journal of Food Engineering*, vol. 143, pp. 90–101. <https://doi.org/10.1016/j.jfoodeng.2014.06.041>.
3. (2012). *Professionalnyye izmereniya klimata v pomeshcheniyakh* [Professional measurements of indoor climate]. *SOK. Santekhnika. Otopleniye. Konditsionirovaniye – Plumbing, Heating, Conditioning, Energy Efficiency*, no. 4, pp. 64–66 (in Russian).
4. Ower, E. & Pankhurst, R. C. (2014). *The Measurement of Air Flow*. United Kingdom, Oxford: Pergamon, 384 p.
5. Örlü, R. & Vinuesa, R. (2017). Thermal anemometry. *Experimental Aerodynamics*. CRC Press, pp. 257–304. <https://doi.org/10.1201/9781315371733-12>.
6. Ikeya, Y., Örlü, R., Fukagata, K., Alfredsson, P. H. (2017). Towards a theoretical model of heat transfer for hot-wire anemometry close to solid walls. *International Journal of Heat and Fluid Flow*, vol. 68, pp. 248–256. <https://doi.org/10.1016/j.ijheatfluidflow.2017.09.002>.
7. Saremi, S., Alyari, A., Feili, D., & Seidel, H. (2014). A MEMS-based hot-film thermal anemometer with wide dynamic measurement range. *Proceedings IEEE Conferences on Sensors (SENSORS'2014)*. Valencia, Spain, 2–5 November 2014, pp. 420–423. <https://doi.org/10.1109/ICSENS.2014.6985024>.
8. Taratykin, K. Ye. & Chernovanov, D. V. (2017). *Otsenka tochnosti opredeleniya raskhoda vozdukh v sistemakh ventilyatsii pri ikh pasportizatsii* [Assessment of the accuracy of determining the air flow rate in ventilation systems during their certification]. *AVOK – ABOK*, no. 3, pp. 54–59 (in Russian).
9. Tsakanyan, O. S. & Koshel, S. V. (2020). Integral thermo-anemometers for average temperature airflow measurement in ducts, at anemostat outlets and in ventilation grilles. *Journal of Mechanical Engineering*, vol. 23, no. 4, pp. 14–21. <https://doi.org/10.15407/pmach2020.04.014>.

Received 28 May 2021

## Вибір конструкції універсального повітрозбірника для термоанемометричного витратоміра циліндричної форми

О. С. Цаканян, С. В. Кошель

Інститут проблем машинобудування ім. А. М. Підгорного НАН України,  
61046, Україна, м. Харків, вул. Пожарського, 2/10

Вимірювання витрати повітря на виходах повітророзподільних пристроїв в системах вентиляції пов'язано з великими труднощами через різноманіття цих пристроїв. На виходах анемостатів, вихрових дифузоров, решіток може спостерігатися закрутка повітряного потоку, його різке стиснення або розширення, зміна напрямку і т.д., що призводить до великих похибок при вимірюваннях. Тому існувала необхідність в розробці універсального вимірювального пристрою, який дозволив би проводити вимірювання витрати повітря з високою точністю. Він повинен складатися з повітрозбірника (для збірки і перетворення потоків повітря в прямолінійний) і датчика для вимірювання витрати повітря (інтегрального термоанемометра). Проведено дослідження декількох конструкцій повітрозбірників. Як раціональний обрано повітрозбірник параболічної форми. Він має невеликий аеродинамічний опір і добре перерозподіляє повітряний потік. Для зниження впливу турбулізації і закрутки повітря до повітрозбірника приєднується циліндричний заспокоїливий канал, в який вбудована випрямляюча решітка

у формі восьмикінцевої зірки. Експериментальні дослідження на різних повітророзподільних пристроях дозволили отримати уточнену градувальну залежність для інтегрального термоанемометра, за якою розраховується витрата повітря. Вплив аеродинамічного опору витратоміра на витрату повітря враховується поправкою, яку необхідно вносити в виміряні значення.

**Ключові слова:** повітрозбірник, термоанемометр, вимірювання.

## Література

1. Воздухораспределительные устройства [Электронный ресурс]: каталог / VENTS: официальный сайт. Киев, 2013. 101 с. – Режим доступа: [https://js.com.ua/upload/iblock/311/15\\_1156\\_cat\\_file.pdf](https://js.com.ua/upload/iblock/311/15_1156_cat_file.pdf).
2. O'Sullivan J., Ferrua M., Love R., Verboven P., Nicolai B., East A. Airflow measurement techniques for the improvement of forced-air cooling, refrigeration and drying operations. *J. Food Eng.* 2014. Vol. 143. P. 90–101. <https://doi.org/10.1016/j.jfoodeng.2014.06.041>.
3. Профессиональные измерения климата в помещениях. *СОК. Сантехника. Отопление. Кондиционирование*. 2012. № 4. С. 64–66.
4. Ower E., Pankhurst R. The measurement of air flow. United Kingdom, Oxford: Pergamon, 2014. 295 p.
5. Örlü R., Vinuesa R. Thermal anemometry. *Experimental Aerodynamics*. CRC Press. 2017. P. 257–304. <https://doi.org/10.1201/9781315371733-12>.
6. Ikeya Y., Örlü R., Fukagata K., Alfredsson P. H. Towards a theoretical model of heat transfer for hot-wire anemometry close to solid walls. *Intern. J. Heat and Fluid Flow*. 2017. Vol. 68. P. 248–256. <https://doi.org/10.1016/j.ijheatfluidflow.2017.09.002>.
7. Saremi S., Alyari A., Feili D., Seidel H. A MEMS-based hot-film thermal anemometer with wide dynamic measurement range. *Proc. of the IEEE Conf. on Sensors (SENSORS'2014)*. Valencia, Spain. 2–5 November 2014. P. 420–423. <https://doi.org/10.1109/ICSENS.2014.6985024>.
8. Таратыркін К. Е., Черноиванов Д. В. Оценка точности определения расхода воздуха в системах вентиляции при их паспортизации. *АВОК*. 2017. № 3. С. 54–59.
9. Tsakanyan O. S., Koshel S. V. Integral thermo-anemometers for average temperature airflow measurement in duct, at anemostat outlets and in ventilation grilles. *J. Mech. Eng.* 2020. Vol. 23. No. 4. P. 14–21. <https://doi.org/10.15407/pmach2020.04.014>.