

A. BYKHUN, P. GLADKIKH, I. KARNAUKHOV, V. LYASHCHENKO, A. MYTSYKOV,
V. RIDOZUB, V. SELIVANOV, V. STOMIN, A. TERTYCHNYJ, I. USHAKOV,
A. ZELINSKY

National Science Center Kharkov Institute of Physics and Technology,
Nat. Acad. of Sci. of Ukraine

(1, Academichna Str., Kharkiv 61108, Ukraine; e-mail: zelinsky@kipt.kharkov.ua)

REACTIVITY MEASUREMENT METHODS AND THE FIRST RESULTS OF THE PHYSICAL START-UP FOR THE NUCLEAR SUBCRITICAL FACILITY “NEUTRON SOURCE”

UDC 539

The methods of the neutron-physical parameter measurements of the subcritical assembly neutron source driven with an electron linear accelerator during start-up are described in the article. The results of neutron multiplication factor and reactivity measurements by different methods are represented. The measurement results are compared with each other and with simulation results of MCNPX code. The measured results of the facility parameters are analyzed.

Keywords: subcritical assembly, neutron multiplication factor, accelerator driven system, electron linear accelerator.

1. Introduction

National Science Center “Kharkov Institute of Physics and Technology” (NSC KIPT) together with Argon National Laboratory (ANL), Chicago, USA develop a neutron source on the base of sub-critical assembly (SCA) driven with an electron linear accelerator of 100 MeV particle energy, with average beam power of 100 kW and with neutron generating target (NGT) [1]. During interaction of the 100 MeV electrons with

a tungsten or uranium target γ -quanta are generated and then, through (γ, n) reaction, the source neutrons necessary for the facility operation are produced. With the use of uranium NGT the neutron yield is increased essentially due to ^{238}U fission at high energy γ -quanta.

As it was shown with MCNPX code simulations [2], in the SCA core either 38 fuel assemblies for the case of tungsten NGT (neutron multiplication factor $k_{\text{eff}} \leq 0.96$), or 37 fuel assemblies for the core configuration with uranium NGT ($k_{\text{eff}} \sim 0.98$), should be loaded [3]. The physical start-up of the facility is performed with tungsten NGT. The uranium fuel assemblies of WWR-M2 type with uranium dioxide of 19.7% ^{235}U enrichment and aluminum SAV-1 alloy cladding are used as a fuel.

2. The Neutron Source Facility

The main NSC KIPT “Neutron Source” facility parameters are shown in Tab. 1.

The layout of the facility core is shown in Fig. 1. SCA is set in a tank (Fig. 2) of aluminum SAV-1 alloy

Citation: Bykhun A., Gladkikh P., Karnaukhov I., Lyashchenko V., Mytsykov A., Ridozub V., Selivanov V., Stomin V., Tertychnyj A., Ushakov I., Zelinsky A. Reactivity measurement methods and the first results of the physical start-up for the nuclear subcritical facility “Neutron Source”. *Ukr. J. Phys.* **68**, No. 3, 147 (2023). <https://doi.org/10.15407/ujpe68.3.147>.

Цитування: Бихун О., Гладких П., Карнаухов І., Лященко В., Мициков А., Рідозуб В., Селіванов В., Стомін В., Тертичний А., Ушаков І., Зелінський А. Методи вимірювання реактивності та перші результати фізичного пуску ядерної підкритичної установки “джерело нейтронів”. *Укр. фіз. журн.* **68**, № 3, 147 (2023).

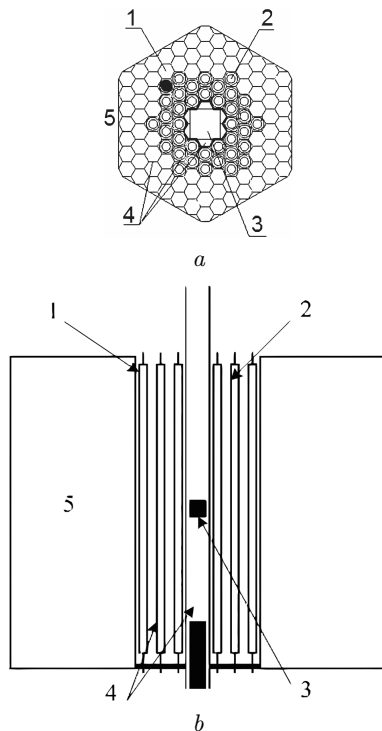

Fig. 1. Layout of the SCA core. (a) is horizontal cross section; (b) is a vertical cross section: 1 – beryllium reflector elements, 2 – fuel assemblies, 3 – NGT, 4 – cooling water of the SCA and NGT cooling loops, 5 – graphite reflector. The fuel assembly marked with black circle is installed for operation with tungsten target. For operation with uranium target the beryllium reflector element is installed instead the fuel assembly

at a ground level. All SCA elements are installed in a spacing grid. The SCA tank is filled with the distilled water that works as the moderator and core collant. NGT is installed in the center of the SCA core.

Electron beam is transported at the NGT from the linear accelerator [4] with 90° bending down transportation channel [5]. The transportation channel consists of two 45° dipole magnets, beam focusing elements, beam scanning system and beam instrumentation elements (Fig. 2).

Three measuring channels are used for neutron flux measurements in the NSC KIPT SCA “Neutrion Source”. Each channel includes three different types of neutron detectors of different sensitivity. Fission chambers by FOTONIS (France) production are used as the detectors. Three detectors of CFUF34 type (L detector) and three detectors of CFUF54 type (H detector) are installed above graphite reflector at 849 mm distance from the SCA core basement and

at 540 mm from the NGT center in radial direction. Three detectors of CFUF28 type (M detector) are installed in 90 mm above median plane and out of graphite reflector at 625 mm distance from the NGT center.

Detectors of the same type are set under 120° angle to each other in horizontal plane. CFUF34 detectors and CFUF54 detectors are positioned under 60° angle in each measuring channel (Fig. 3). Efficiencies of the thermal neutron registration for the detectors are 10^{-3} for CFUF34, 10^{-5} for CFUF54 and 10^{-2} for CFUF28. Detectors CFUF34, CFUF54 can work in counting and fluctuation mode. Furthermore, detectors CFUF28 can be operated in the current mode. Detectors are distributed along the channels as a following: Channel A includes detectors L(3), H(4), M(8), Channel B includes detectors L(1), H(2), M(7) and Channel C includes detectors L(5), H(6), M(9). Detectors that are installed above graphite reflector are used during the facility start-up for neutron flux measurements (L and H detectors). Three detectors (M-detectors) are installed in the median plane behind the graphite reflector for the neutron flux monitoring in the neutron output channels. Detectors CFUF34 are used during physical start-up and CFUF54 detectors with full core loading and full electron beam power. It is possible to start use

Table 1. Main parameters of the NSC KIPT SCA “Neutrion Source” facility

Parameter	Value
Electron energy, MeV	100
Electron beam average power, kW	100
Neutron generating target	U, W
Neutron multiplication factor k_{eff}	Not more then 0.98
Fissionable material of the core	Uranium with 19.7% of ^{235}U
Neutron reflector	Two zone: intrinsic zone is beryllium, outside zone is graphite
Moderator, coolant	Demineralized water (H_2O)
Neutron flux at the core, $\text{n}/\text{cm}^2\text{s}$	1.95×10^{13} (U) 1.14×10^{13} (W)
Energy release, kW	192 (U) 131 (W)

of CFUF54 detectors for the k_{eff} and reactivity estimation during physical start-up beginning from 24 loaded fuel assemblies.

As it is determined in regulatory document [6], physical start-up of a nuclear facility includes consistent loading of fuel assemblies into the facility core with following measurements of the facility physical parameters. In accordance with the physical start-up program, the loading of the fuel elements into the core of the NSC KIPT SCA “Neutron Source” includes the following stages:

- 3 loads of 4 fuel assemblies in one load;
- 9 loads of 2 fuel assemblies in one load up to 30 fuel assemblies in the SCA core;
- loading of 1 fuel assembly in one load up to 35 assemblies in the SCA core;
- preparation of the report on the 35 fuel assemblies loading;
- receiving of the separate permission of the State Nuclear Regulatory Inspectorate of Ukraine (SNRI) for the last 3 assemblies loading;
- loading of the last 3 fuel elements, one fuel assembly in one loading.

After loading of 38 fuel assemblies and completion of necessary measurements the report on physical start-up results is generated and submitted to SNRI. The report accepted by SNRI is a background to start the facility pilot operation stage.

In accordance with the NSC KIPT SCA Neutron Source physical start-up program, at each stage of the fuel loading at the core the measurements of the following neutron-physical parameters should be performed:

- measurement of neutron multiplication factor k_{eff} with neutron multiplication method;
- measurement of reactivity (ρ) with area-ratio method;
- on-line monitoring of the facility reactivity with flux-to-current ratio method.

3. Methods of the Subcritical Reactivity Measurements of the NSC KIPT SCA “Neutron Source”

3.1. Measurements of k_{eff} with neutron multiplication method

SCA increases the intensity of source neutrons N_0 by factor $(1 - k_{\text{eff}})^{-1}$ [7]:

$$N = \frac{N_0}{(1 - k_{\text{eff}})}, \quad (1)$$

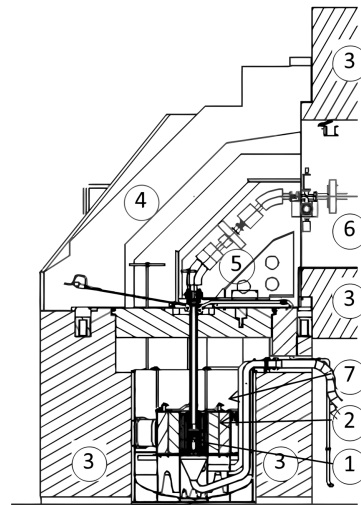

Fig. 2. Layout of the NSC KIPT SCA Neutron Source core, bio-shield, bending part of the beam transportation channel. Vertical cross section. 1 – NGT, 2 – SCA with fuel assemblies, beryllium and graphite reflectors, 3 – bio-shield, 4 – movable part of the bio-shield, 5 – beam bending part of the transportation channel, 6 – horizontal part of the electron beam transportation channel, 7 – neutron detectors

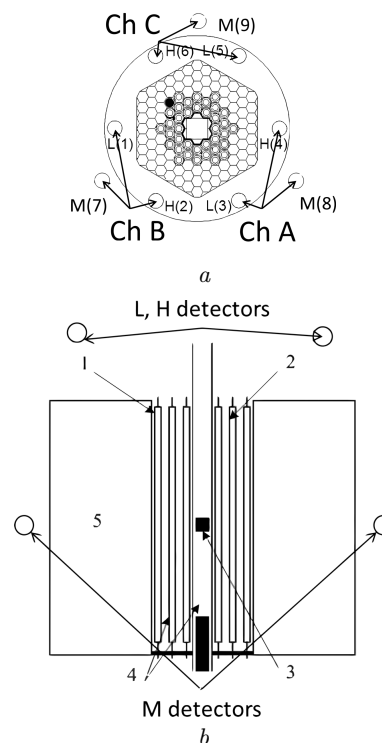

Fig. 3. Layout of the neutron detector distribution in the NSC KIPT SCA “Neutron Source”. A is horizontal cross section, B is vertical cross section

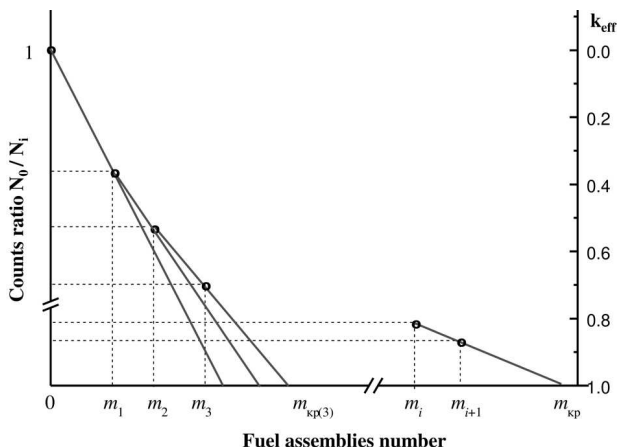

Fig. 4. Inverse multiplication curve (1/N) drawing

where N is a neutron intensity of a SCA; N_0 is an intensity of neutron source without fuel; k_{eff} is neutron multiplication factor.

So, the subcritical assembly acts as a neutron amplifier for the source neutrons.

At this feature of SCA the method of the neutron multiplication factor measurement during the fuel loading in the SCA core, called “neutron multiplication method”, is based [7].

Before fuel loading start the number of source neutrons N_0 registered during the fixed time with certain electron beam current should be measured. At each stage of the fuel loading the number of neutrons N_i is registered with the same electron beam current and during the same time. Inverse multiplication curve (1/N) is drawn. At the x -axis one should put the number of loaded fuel assemblies. At y -axis the value of N_0/N_i ratio is put, where i is a number of loaded fuel assemblies (Fig. 4). Extending the straight line connected two next measurements to the intersection with x -axis one can get the number of fuel assemblies corresponds to the k_{eff} value equal to 1 (criticality condition) at each stage of fuel loading. The value of k_{eff} can be written from (1) as:

$$k_{\text{eff}} = 1 - \frac{N_0}{N_i}. \quad (2)$$

Due to difference in energy spectrums of source neutrons and neutrons of fission at the following loading stages the accuracy of the method is low. The average neutron energy in the fission spectrum is about 2 MeV, at the same time, the energy spectrum of

source neutrons from NGT in the core is extended up to 90 MeV. The neutron multiplication method can be used only to estimate the critical number of fuel assemblies (corresponds to $k_{\text{eff}} \sim 1$) (Fig. 4) and approximate value of k_{eff} .

The methodic of the k_{eff} value measurements during fuel loading to the NSC KIPT SCA “Neutron source” core was the following:

1. With zero loading of the core (fuel dummies are installed instead of fuel assemblies), in order to provide required statistic accuracy of the measurements, the number of source neutrons of about $N_0 \approx 10^4$ are registered with CFUF34 detectors with fixed value of the accelerator pulse current and number of the accelerator beam pulses. During the measurements the number of electrons at the NGT is registered (electron charge at NGT).

2. After loading of i -th set of fuel assemblies the number of N_i neutrons are registered with the corresponded CFUF34 detectors. The measurements are performed with series at 5 in a row.

3. All N_i measurements of neutron multiplication method are performed with the same electron charge at the NGT and equal to the charge registered during N_0 measurements.

4. After inverse multiplication curve (1/N) drawing and k_{eff} determination the critical number of fuel assemblies are determined.

The items 2–4 are repeated during each stage of fuel loading.

3.2. Area-ratio method

Area-ratio method is one of the methods that use the pulse external neutron source for the system reactivity measurements. In such kind of measurements, the external source is a regular sequence of short neutron pulses. In the case of the NSC KIPT “Neutron source” the neutron pulses are generated with pulse electron beam of the accelerator. Typical pulse length in the measurements is about 1 μs . The time between two electron pulses (pulse repetition rate) is chosen bigger than decay time of the prompt neutrons and less than decay time of the delayed neutron precursor. The typical value of the pulse repetition rate is $20 \leq T \leq 50$ ms [8].

The area-ratio method is based at the kinetic equations of point reactor model [8]:

$$\frac{d}{dt}P(t) = \frac{\rho - \beta_i}{\Lambda}P(t) + \sum \lambda_i C_i(t) + S, \quad (3)$$

$$\frac{d}{dt}C_i(t) = \frac{\rho - \beta_i}{\Lambda}P(t) - \lambda_i C_i(t), \quad i = 1 \dots 6, \quad (4)$$

where S is the intensity of the external source (number of neutrons per time), P is the number of neutrons in the core at time moment t , C_i is the i -th group delayed neutron precursor density function, λ_i is the i -th group precursor decay constant, β_i is the effective delayed neutron of i -th fraction, ρ is the reactivity, Λ is the mean generation time of the subcritical assembly.

The solution of the equations in steady state conditions after integrating over time gives the reactivity value in dollars:

$$\frac{\sum n_p}{\sum n_d} = -\frac{\rho}{\beta_{\text{eff}}} = -\rho_s, \quad (5)$$

where $\sum n_p$ and $\sum n_d$ are the total number of prompt and delayed neutrons in neutron pulse response, β_{eff} is the average effective delayed neutron fraction.

To get dimensionless value of the reactivity one should multiply the value of Eq. (5) by average effective delayed neutron fraction β_{eff} . For the case of the NSC KIPT SCA “Neutron Source” β_{eff} was calculated with MCNPX code and is equal to $\beta_{\text{eff}} = 0.00748$.

Fig. 5 helps to understand the area-ratio method [8]. During a certain time after NGT bombarding with electron beam the quasi stationary mode of the neutron flux should be set. As it can be seen from Fig. 5, the neutron pulse response includes prompt neutrons marked as PN and delayed neutrons marked as DN. The number of prompt and delayed neutrons are proportional to the areas PN and DN under neutron pulse response curve. From this proportion the name of the reactivity measurement method is originated as “area-ratio method”.

It is necessary to measure neutron pulse response with the required statistical validity. The maximum reactivity measurement accuracy was chosen as $\varepsilon = \Delta\rho/\rho = 0.5\%$. Such accuracy will be enough to determine the reactivity of completely loaded core with uranium NGT, when the neutron multiplication factor is equal to $k_{\text{eff}} \approx 0.98$ and reactivity is near zero $\rho = (k_{\text{eff}} - 1)/k_{\text{eff}} \approx k_{\text{eff}} - 1 = -0.02$. During the first steps of the fuel loading with low values of k_{eff} the accuracy of the reactivity measurement will be mainly determined by the statistics of the delayed neutron registration because the number of quasi stationary

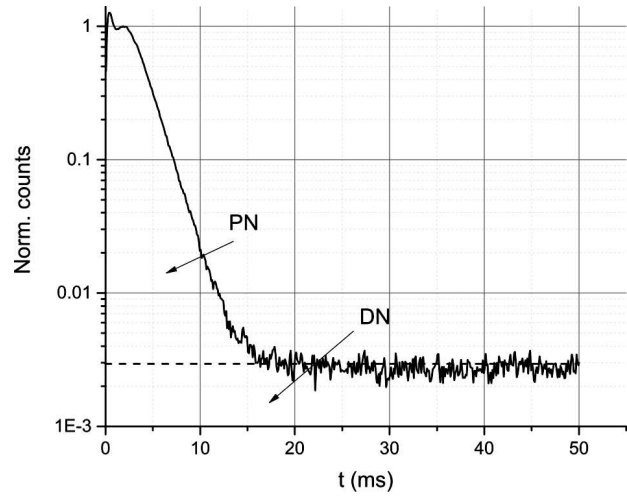

Fig. 5. Area-ratio method

precursors of the delayed neutrons is low and value of relation PN/DN is high. As the simulation results showed, it is required quite a long time even with maximum core loading to provide statistics required for such reactivity measurement accuracy. But with small amount of fuel assemblies requirements to the accuracy could be reduced, because the neutron multiplication factor value is far from 1 and subcritical assembly is deeply subcritical. We assumed, that with small loading (4, 8 and 12 fuel assemblies in the core), the accuracy of the reactivity measurement with area-ratio method should be about 2%. As the number of loaded assemblies will be increased the requirement to the measurement accuracy will become stronger up to = 0.5% beginning from 30 fuel assemblies in the SCA core. The procedure of the reactivity and k_{eff} measurements with area-ratio method during the NSC KIPT physical start-up is similar to the procedure of measurements with neutron multiplication method, but because the method requires good statistics on delayed neutron number the number of electron pulses is used during the measurements and the value of collected electron charge at NGT should be increased at least by one order.

3.3. Flux-to-current ratio method

Flux-to-current ratio method was accepted for on-line monitoring of the reactivity perturbation of the NSC KIPT SCA Neutron Source. As it can be formulated from point kinetics equations (3), (4) assuming that the subcritical core is driven with a steady state ex-

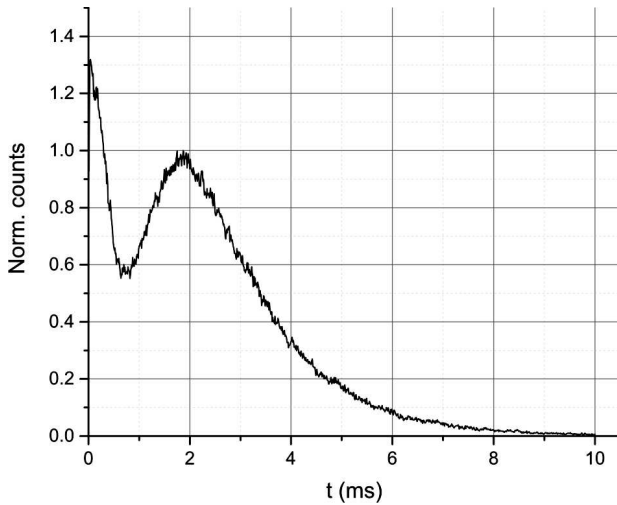

Fig. 6. Neutron pulse response for the NSC KIPT SCA “Neutron Source” with “zero” fuel loading (MCNPX simulations)

ternal source of intensity S , the reactivity ρ is:

$$\rho = -\frac{S\Lambda}{P}. \quad (6)$$

For ADS the external source intensity S is directly proportional to the current of the accelerator beam. The power of the system can be replaced by the response of certain neutron detector. So, during operation, the expression for reactivity ρ can be formulated to be inversely proportional to the flux to current ratio:

$$\rho = C \frac{I}{\langle \varepsilon \sigma_d \phi \rangle_E}, \quad (7)$$

where C is a constant, I is the accelerator beam current, ε is a neutron detector sensitivity, σ_d is a detector cross section, Φ is neutron flux value at a detector position, and $\langle \varepsilon \sigma_d \phi \rangle_E$ is the neutron detector response at the detector location averaged on neutron energy spectrum.

The absolute value of the constant C is complicated to be determined but if assume that the reactivity in reference state is known:

$$\rho_{\text{ref}} = C \frac{I_{\text{ref}}}{\langle \varepsilon \sigma_d \phi_{\text{ref}} \rangle_E}, \quad (8)$$

the reactivity in the subcritical assembly in the state n that is different from the reference state can be determined as:

$$\rho_n = \rho_{\text{ref}} \frac{\Phi_{\text{ref}}/I_{\text{ref}}}{\Phi_n/I_n}. \quad (9)$$

The flux-to-current ratio method is simple and is easy to be implemented for ADS because the beam current and neutron flux are under constant monitoring in a facility.

4. Selection of the External Source Parameters

To implement the area-ratio method for the reactivity measurements in the NSC KIPT SCA “Neutron Source”, first of all, it is necessary to select the parameters of the external neutron source. To provide average electron beam power of 100 kW the design parameters of the linear accelerator driver of SCA are the following [4]:

- electron beam energy is 100 MeV,
- maximum pulse current is 600 mA,
- beam pulse duration is 2.7 μs ,
- beam pulse repetition rate is 625 Hz.

The values of beam pulse current and beam pulse repetition rate can be varied within ranges 15–600 mA and 2–625 Hz respectively.

To measure SCA neutron pulse response during physical start-up it is necessary to choose the value of electron beam repetition rate and value of electron beam pulse current allow to provide reliable registration of delayed neutrons in the SCA. For this purpose, the neutron pulse response of the SCA was simulated with MCNPX code without uranium fuel assemblies in the core. Instead of fuel assemblies the fuel dummies from aluminum alloy SAV-1 with the same geometrical shape and hydraulic resistance were put in the SCA core. The results of the simulation are shown in Fig. 6. As it can be seen from the figure, in the case of “zero” loading the prompt neutrons are decayed during 10 ms.

Simulation results with “full” core fuel loading of 38 fuel assemblies show the prompt neutron decay time equal to 25 ms. Fig. 5 shows the example of simulation of normalized neutron pulse response for 24 loaded fuel assemblies. In this case the prompt neutrons are decayed in the system during 15 ms. Thus, it can be concluded, to provide reliable registration of steady state delayed neutrons the repetition rate of the external neutron source pulses (accelerator beam pulses) should be chosen of 50 ms that corresponds to electron beam pulse frequency of 20 Hz.

The pulse beam current value was chosen of 35–40 mA to provide, on the one hand, acceptable neu-

tron registration rate and, therefore, implementation of CFUF34 detectors till “full” fuel loading in the core, on the other hand, to provide the match of measurement results of CFUF34 and CFUF54 detectors during fuel loading procedure for further use of CFUF54 detectors on the facility full power operation. To provide physical start-up procedure the stable mode of the accelerator operation was adjusted with electron beam energy of 100 MeV, beam pulse repetition rate of 20 Hz and pulse beam current $\approx 35\text{--}40$ mA [9].

5. Time Required for Steady State Neutron Flux Setting

Condition of steady state neutron balance is characterized by relation $dC/dt = 0$. It means that the rate of precursor generations in the SCA core due to ^{235}U fission is equal to velocity of the precursor decay.

After series of source neutron pulses (accelerator beam pulses) the average neutron flux became steady state and delayed neutrons reach an equilibrium.

Simulations with MCNPX code for 24 and 38 loaded fuel assemblies in the NSC KIPT SCA “Neutron Source” core with 20 Hz accelerator repetition rate and pulse current of 40 mA showed that to approximate steady state neutron flux with 10^{-4} accuracy it is needed time of about 180 and 240 s correspondingly [8]. The same results are obtained with use of analytical expressions of [10].

Since the time of accelerator beam adjustment after beam switch-on takes more than 10 minutes, the neutron flux measurements in steady state mode can be started right after completion of the accelerator beam adjustment. Accelerator beam should be switched on during the whole time of the measurements including the time between measurement sessions with the same pulse current and repetition rate. In the case of the beam stops, the neutron measurements can be resumed after, at least, 5 minutes since the electron beam start.

6. Method of the Registered Event Collection

One of the registration method of the SCA neutron pulse response on the external neutron pulse is direct registration of event time relative to the synchro-pulse of the electron accelerator beam. As a result, one has data-file with registered event times [11]. After further data processing the neutron pulse response as a function of registered neutron number versus time be-

tween two electron beam pulses can be plotted. The disadvantage of this method is absence of on-line information about neutron flux during long time of the statistically provided measurement session. Despite that disadvantage, such method can be useful for analysis of time distributions of the neutron flux.

For the physical start-up of the NSC KIPT SCA “Neutron Source” it was decided to use another method of data collection and neutron pulse response registration. The method was taken from the astronomic measurements and measurements of very weak signals with high level of noise background. The method enhances signal-to-noise ratio by summarizing results of many measurements in the same time intervals and was called “coherent summarizing method” [12]. Due to such summarizing the signal is summarized in proportion to the number of measurements N but noises in proportion to $N^{1/2}$.

The accelerator synchronization system provides all facility systems with correspondent synchronization pulses to synchronize their work. The front of the synchronization pulse corresponds to the beginning of each electron beam bunch. The synchronization pulse starts the system of the neutron registration and simultaneously starts time gate system dividing the time period between two beam pulses at equal time intervals (strobes). The certain registered event is written in the time interval that corresponds to the time of its registration. During many numbers of the electron bunches the events are accumulated in each time interval in accordance to the registration time between beam bunches and a facility operator can monitor the neutron pulse response on-line. The duration of the time interval for the data collection (strobe duration) can be set by the operator within the range between $1\ \mu\text{s}$ to $100\ \mu\text{s}$.

Therefore, operator can monitor the measurement results from the very beginning of the neutron counting session on-line and preliminary estimate the measurement results.

During physical start-up of the NSC KIPT SCA “Neutron source” the time strobe duration was chosen as $5\ \mu\text{s}$, that with chosen 20 Hz electron beam repetition rate corresponds to the 10000 time intervals.

7. Preparation to the Measurements and Validation of the Measurement Results

Before the start of the fuel loading procedure and the facility reactivity measurements the CFUF34 neutron

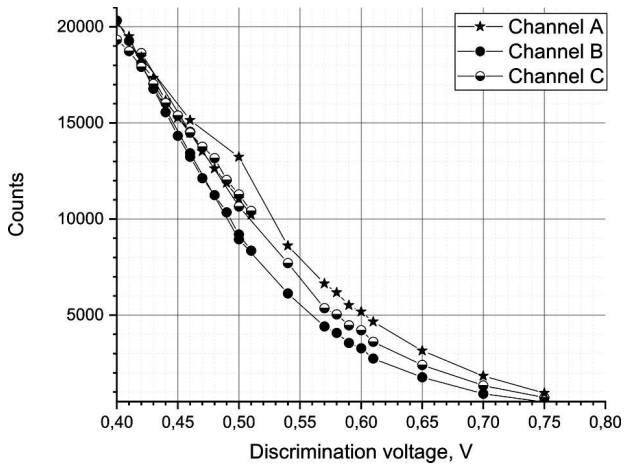

Fig. 7. Discrimination curves of CFUF34 neutron detectors of the NSC KIPT SCA “Neutron Source” neutron flux measurement system

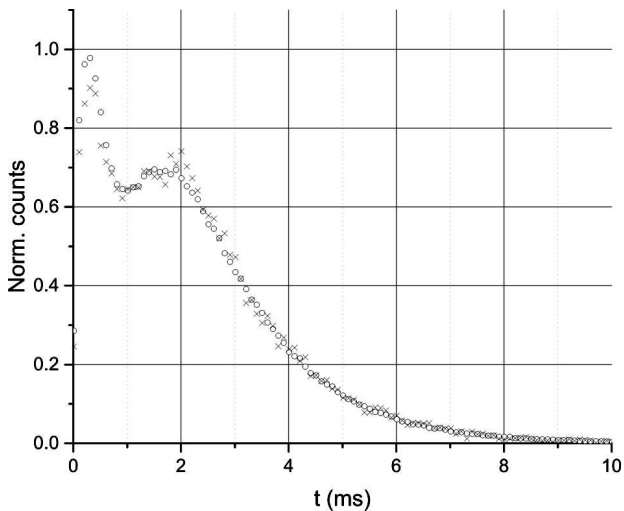

Fig. 8. Neutron pulse response: measured (cross marks) and simulated with MCNPX code (circle marks)

detector discrimination curves were measured in real radiation conditions and with detectors high voltage value $V = 400$ V. The measured curves are shown in Fig. 7. On the base of measurement results, the basis value for discrimination voltage of 0.6 V was chosen for all three CFUF34 detectors. Such choice was made for two reasons:

- detectors manufacturer FOTONIS (France) recommended the operation range for the discrimination voltage of 0.6–0.9 V in the detector passports,
- the parts of discrimination curves between 0.56 and 0.61 V are linear and with minimal slope.

During further reactivity measurements with area-ratio method few different values of the discrimination voltage were used and the results were compared (see item 7.4 of this article) to investigate the dependence of reactivity value on discrimination voltage value, but the basis value of the discrimination voltage was the same and equal to 0.6 V.

After selecting the discrimination voltage the value of N_0 was measured for each CFUF34 detector with accumulated electron charge of $399 \mu\text{C}$ that provides necessary neutron count statistics (more than 10 000 registered events). The values of N_0 are the following:

L(3) Channel A: 15586,

L(1) Channel B: 11930,

L(5) Channel C: 18187.

The further measurements with neutron multiplication methods were performed in series of 5–6 measurements with about $400 \mu\text{C}$ accumulated electron beam charge and results were normalized to $400 \mu\text{C}$.

To be convinced in the correctness of the equipment functioning of the NSC KIPT SCA “Neutron Source” neutron flux measurement system two tests of the obtained experimental data were performed at the starting stage of the fuel loading (12 fuel assemblies loaded in the facility core).

At first, the shapes of the measured normalized neutron pulse response and simulated with MCNPX code normalized neutron pulse response were compared. An example of such comparison with 12 loaded fuel assemblies is shown in Fig. 8. As it is clear from the figure, the agreement between calculation results and experimental data is quite satisfactory and one can state that measured values of reactivity and k_{eff} are accurate.

The second test was analysis of the statistics of delayed neutron registration. Such analysis has been carried out for 12 loaded fuel assemblies. During the measurements the statistics of average four registered neutrons per $5 \mu\text{s}$ time interval was collected. In Fig. 9 the normalized distribution on registered neutron counts, normalized Poisson distribution with mean value equal to four and normal distribution with mean value and dispersion equal to four are shown. All distributions are normalized to their value at the maximum. It is clear from the figure that experimental data practically matches with Poisson distribution that is correct for the rare independent events with certain mean value. It confirms that

neutron registration system hardware and software do not register the false events.

8. Measurement Results

8.1. Neutron multiplication method

To determine reactivity and k_{eff} with the neutron multiplication method, a series of 5–6 measurements each of 3600–4600 accelerator pulses in dependence on pulse beam current value were performed at repetition rate $f_{\text{rep}} = 20$ Hz. The continuation of measurement sessions provided collection of about 400 μC at NGT during each session.

The results obtained between loading of 4 and up to 30 fuel assemblies in the SCA core are shown in Tabl. 2.

The average value of measurement error decreased from about 5% for 4 loaded fuel assemblies to about 1% for 30 loaded fuel assemblies.

The total number of registered with CFUF34 detector neutrons during one session was increased from about 20000 neutrons up to 130000 neutrons.

The averaged on three CFUF34 measuring channels inverse multiplication curve for each loading stage from 4 to 30 loaded fuel elements are shown in Fig. 10. The graph shows that the estimated critical number of fuel assemblies is about 41–42 for 30 loaded fuel assemblies. Such value of critical number allows to continue fuel loading in the SCA core in accordance with the physical start-up program one by one with k_{eff} measurement between each assembly loading and up to 35 fuel assemblies in the core.

The results of k_{eff} measurements for each step of fuel loading from 4 to 30 fuel assemblies separately

Table 2. Results of k_{eff} measurements with neutron multiplication method

N_{ass}	k_{eff} Simul.	Detector	k_{eff}	k_{eff} min	k_{eff} max	Spread, %
4	0.275	L(3)	0.312	0.307	0.316	± 1.4
		L(1)	0.295	0.287	0.306	$\mp 2.7\text{--}3.6$
		L(5)	0.327	0.326	0.329	$\mp 0.4\text{--}0.6$
		Average	0.311	0.295	0.327	$\mp 5.1\text{--}5.0$
30	0.862	L(3)	0.888	0.887	0.890	± 0.1
		L(1)	0.877	0.875	0.878	± 0.2
		L(5)	0.895	0.894	0.896	± 0.1
		Average	0.887	0.877	0.895	$\mp 1.1\text{--}1.0$

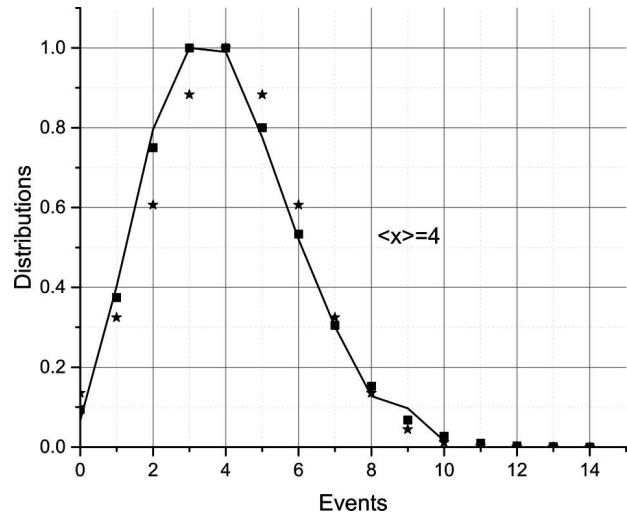

Fig. 9. Measured counts distribution (solid curve), calculated Poisson distribution (square marks), calculated normal distribution (star marks)

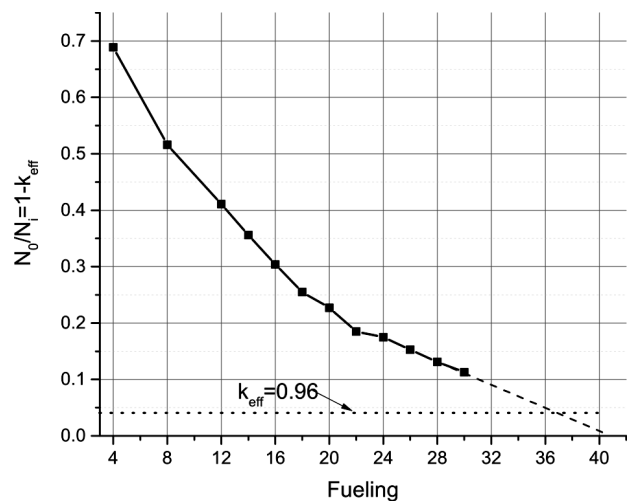

Fig. 10. Averaged on three CFUF34 channels inverse multiplication ($1/N$) curve for each stage of fuel loading from 4 to 30 loaded fuel assemblies

for each measurement channel, averaged on all three channels and MCNPX code simulation results are summarized in Fig. 11. As it can be seen, the results of the measurements with the neutron multiplication method regular give the k_{eff} value a little bit higher that simulated value of k_{eff} but the difference is decreasing with growth of k_{eff} value. Fig. 12 shows the difference between simulated value of k_{eff} and results of the measurements. The difference was decreased

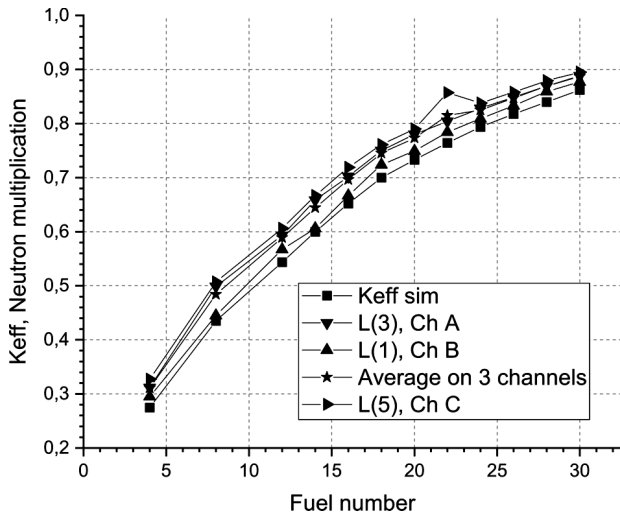

Fig. 11. k_{eff} measured with neutron multiplication method

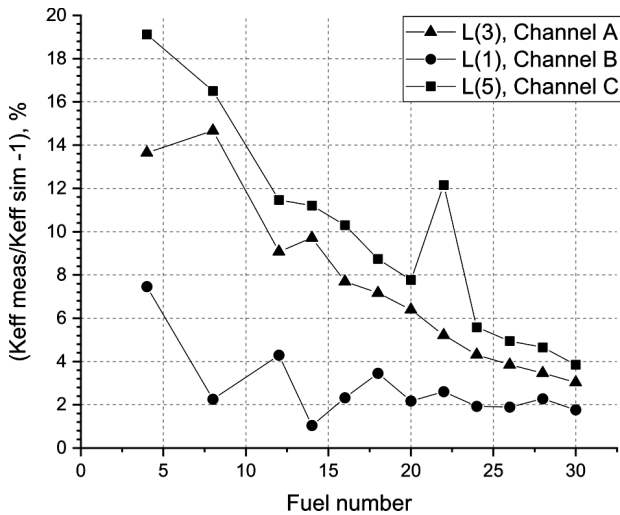

Fig. 12. Deviation of k_{eff} measured with the neutron multiplication method from simulated k_{eff} value

from 8–19% for four fuel assemblies to 2–4% for 30 fuel assemblies.

The results of the measurements are in a good agreement with simulation and allow to continue the procedure of the NSC KIPT SCA “Neutron Source” physical start-up.

8.2. Area-ratio method

To determine reactivity and k_{eff} with the area-ratio method, a series of 5–6 measurements each of 36000–40000 accelerator pulses in dependence on pulse beam

current value were performed at repetition rate $f_{rep} = 20$ Hz. The continuation of measuring sessions provided collection of about 4 mC at NGT during each measuring session.

The results of reactivity ρ_S measurements with area-ratio method between loading of 4 and up to 30 fuel assemblies in the SCA core are shown in Tabl. 3.

The total number of registered with CFUF34 detector neutrons during one session was increased from about 200 000 neutrons up to 1300000 neutrons and number of delayed neutrons was increased from about 550 to 60000.

The results of reactivity ρ and k_{eff} measurements with area-ratio method for each step of fuel loading from 4 to 30 fuel assemblies are summarized in Fig. 13. Fig. 14 shows the deviation of the measured value of k_{eff} from design k_{effsim} value in percent $((\frac{k_{eff}}{k_{effsim}} - 1) \times 100)$. As it can be seen, the results of the measurements with the area-ratio method starting from 12 loaded fuel assemblies have good agreement with simulated values of k_{eff} .

The presented results do not take into account the reactivity value spatial correction. The comparison of the measurement results with and without spatial correction is presented in section 8.5.

8.3. Flux-to-current ratio measurement method

To determine the reactivity of the NSC KIPT SCA “Neutron Source” with flux-to-current ratio method the results of the reactivity measurements with area-ratio method are used as reference reactivity value.

Table 3. Results of reactivity ρ_S measurements with area-ratio method

N_{ass}	ρ_S Simul.	Det.	ρ_S	ρ_S max	ρ_S min	Spread, %
4	-353.3	L(3)	-365.6	-314.5	-400.9	± 13.98 9.67
		L(1)	-372.0	-343.5	-384.9	± 7.58 3.55
		L(5)	-375.97	-357.54	-389.56	± 4.9 3.62
30	-21.4	L(3)	-21.8	-21.6	-22.0	± 0.92
		L(1)	-22.0	-21.8	-22.2	± 0.9
		L(5)	-21.34	-21.2	-21.5	± 0.7

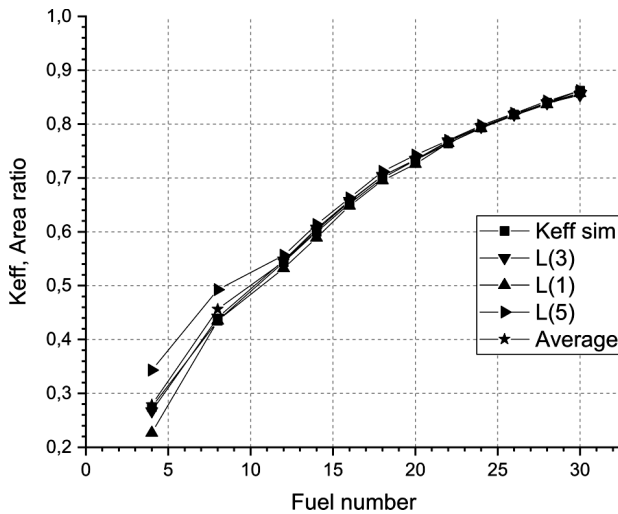

Fig. 13. k_{eff} measurement results with area-ratio method

It is supposed to apply the spatial correction factors calculated by ANL with MCNPX code at each detector location at the corresponding fuel loading stage to produce the reactivity value [8]. The final reactivity at the fuel loading stage is the mean value among all corrected reactivities at CFUF34 detector locations.

To determine the reactivity at i -th step of fuel loading the reference value of reactivity was taken from the measurements at $(i-1)$ -th step of the fuel loading.

Fig. 15 shows the results of reactivity measurements with flux-to-current ratio method comparing with simulation results. Results for flux-to-current ratio method are represented after spatial corrections and averaged on three CFUF34 detectors. Results for area-ratio method are represented without spatial correction. As it is clear from the figure, the measurements with flux-to-current ratio method are in a good agreement with area-ratio method starting from 18 loaded fuel elements.

8.4. Dependence of the measurement results on discrimination voltage value

As it is clear from neutron detector discrimination curves (Fig. 7) with selected discrimination voltage of 0.6 V for all three CFUF34 detectors of 10^{-3} sensitivity the number of registered neutrons in each detector will be different with the most sensitive detector L(5) and the least sensitive detector L(1). Fig. 16 shows the neutron pulse responses for each step of fuel loading from 0 (bottom curve) to 30 (top curve) loaded fuel assemblies normalized at 4 mC collected

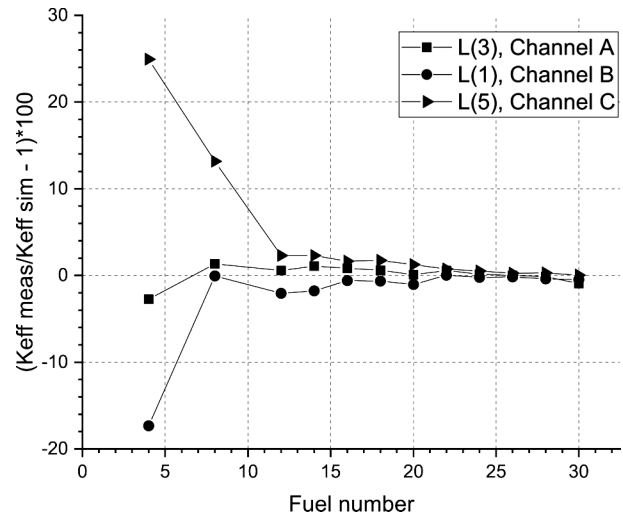

Fig. 14. Deviation of the measured value of k_{eff} from design k_{eff} value in percent

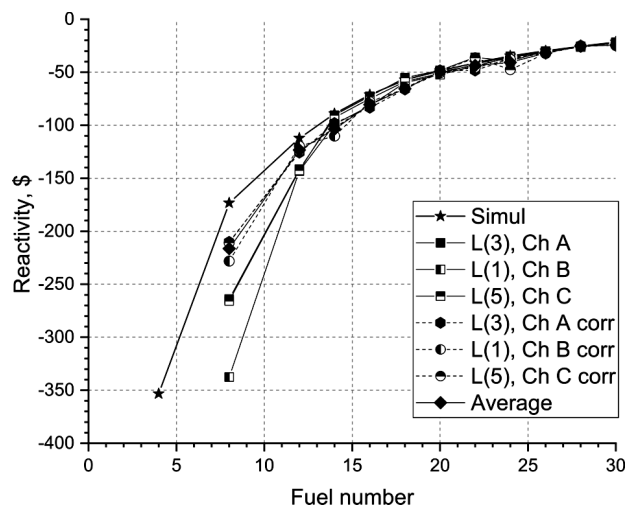

Fig. 15. Reactivity measured with flux-to-current ratio method with spatial correction in comparison with MCNPX simulation results and area-ratio method (\star – simulation results, \blacksquare – area-ratio method results, \bullet – flux-to-current ratio method results with spatial correction, \blacklozenge – averaged on three channels flux-to-current ratio method results with spatial correction)

electron beam charge for L(3) detector. The neutron flux responses for the L(1), L(5) detectors have the similar shape but slightly different amplitudes of registered neutron counts. Fig. 17 shows the increasing of the neutron flux on dependence of loaded fuel assembly number. The number of registered neutron increasing from the core loaded with fuel dummies and core loaded with 30 fuel assemblies is 8.95,

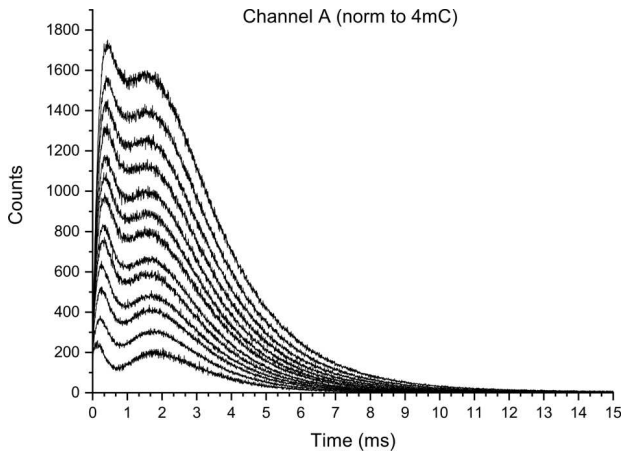

Fig. 16. Neutron pulse responses of L(3) detector (Channel A) for each step of fuel loading from 0 to 30 fuel assemblies

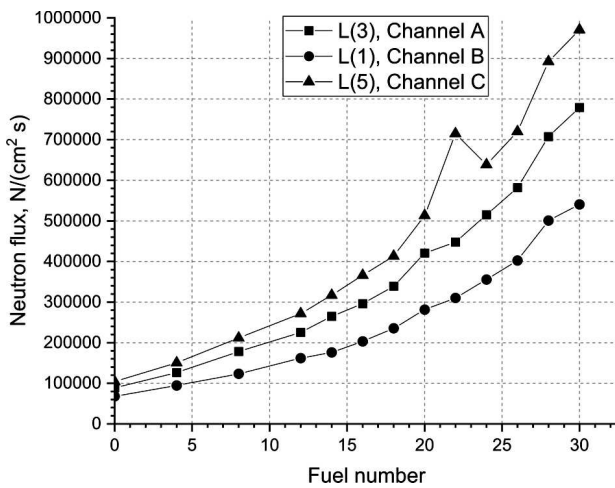

Fig. 17. The value of neutron flux vs number of loaded fuel assemblies for different neutron detectors

8.11 and 9.55 times for detectors L(3), L(1) and L(5) correspondingly.

To study the dependence of measured values of reactivity and k_{eff} on discrimination voltage and, therefore, on the number of registered neutrons in the whole pulse response, four series of measurements with different discrimination voltage and different number of fuel assemblies were performed. The results were compared with results of 0.6 V discrimination voltage measurements and with simulated values of reactivity and k_{eff} .

The typical measurement results are shown in Tabl. 4. The results of four sessions of reactivity ρ

and k_{eff} measurements show the absence of dependence on discrimination voltage value. The difference in measured values of reactivity ρ and k_{eff} with different values of discrimination voltage are within 1%.

8.5. Measurement results and spatial correction

The area-ratio method is based on the assumption that the subcritical core is a point assembly. In reality, the reactivity value measured at different neutron detectors is different [8].

It is common practice to use spatial correction factor known as Bell and Glasstone Factor to correct the measured reactivity value. To calculate the spatial correction factor, one should calculate k_{eff} of the assembly with KCOD of MCNPX. This value should be taken as reference value. After that the values of k_{eff} and reactivity should be calculated with neutron tracking code for certain neutron detector position. The ratio of reference value and tracking value gives the spatial correction factor $\eta = \rho_{\text{ref}}/\rho_{\text{trac}}$. The corrected value of the reactivity will be:

$$\rho_{\text{cor}} = \rho_{\text{meas}} \times \eta, \tag{10}$$

where ρ_{meas} is the reactivity value measured with area-ratio method.

Table 4. k_{eff} and reactivity measured for different values of discrimination voltage U_{disc} with 30 loaded fuel assemblies

U_{disc}	1	2	3	4	Simulation
L(3)	0.42 V	0.42 V	0.47 V	0.6 V	-
L(1)	0.40 V	0.42 V	0.45 V	0.6 V	
L(5)	0.43 V	0.42 V	0.48 V	0.6	
k_{eff}	1	2	3	4	Simulation
L(3)	0.86	0.86	0.86	0.86	0.86
L(1)	0.86	0.86	0.86	0.86	
L(5)	0.86	0.86	0.86	0.86	
$\rho, \%$	1	2	3	4	Simulation
L(3)	-21.80	-21.80	-21.66	-21.80	-21.39
L(1)	-21.83	-22.00	-21.81	-22.00	
L(5)	-21.42	-21.34	-21.38	-21.34	

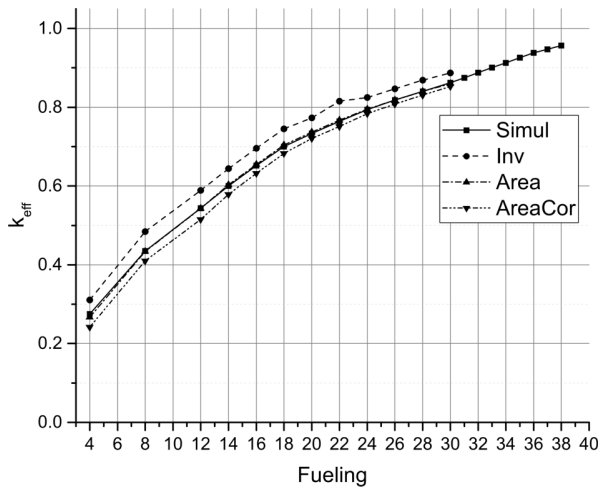

Fig. 18. Calculated and measured with different methods k_{eff} values. “Simul” – simulation results with MCNPX code, “Inv” – measurement results with neutron multiplication method, “Area” – measurement results with area-ratio method, “AreaCor” – measurement results with area-ratio method and spatial correction

Such spatial correction factors were calculated in ANL for all 9 neutron detector positions with use of MCNPX code and used by NSC KIPT to determine corrected value of k_{eff} [8].

Fig. 18 shows dependence of multiplication factor k_{eff} values on number of loaded fuel elements that were measured with neutron multiplication method and area ratio method with and without spatial correction and simulation results of MCNPX code. The data were averaged on all three L type detectors. Analyzing the measurement results representing in Fig. 19 it can be seen, that measured results matched with simulations with accuracy better than 1% but the difference of corrected values with simulation results are between 4 and 10%.

8.6. Use of CFUF54 neutron detectors

Starting from 28 loaded fuel assemblies the number of neutrons registered with CFUF54 detectors became sufficient to provide reasonable measurement statistics and accuracy (more than 10000 registered neutrons from 40000 electron pulses of 35 mA pulse current). It allowed to measure discrimination curves of CFUF54 detectors. Discrimination curves for H(4), H(2) and H(6) detectors are shown in Fig. 19. To provide similarity of the neutron counts with

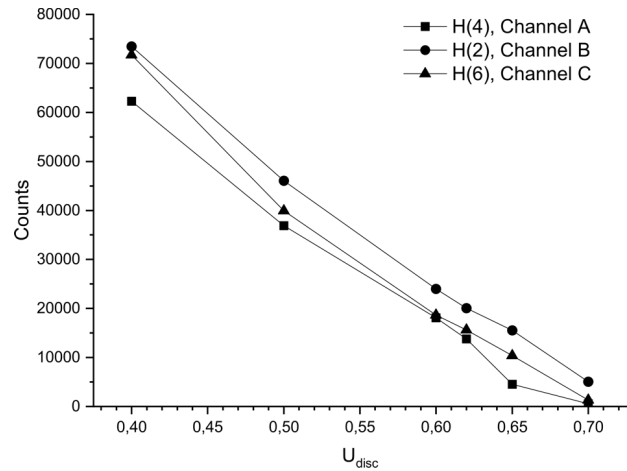

Fig. 19. Discrimination curves for CFUF54 detectors for 28 loaded fuel elements

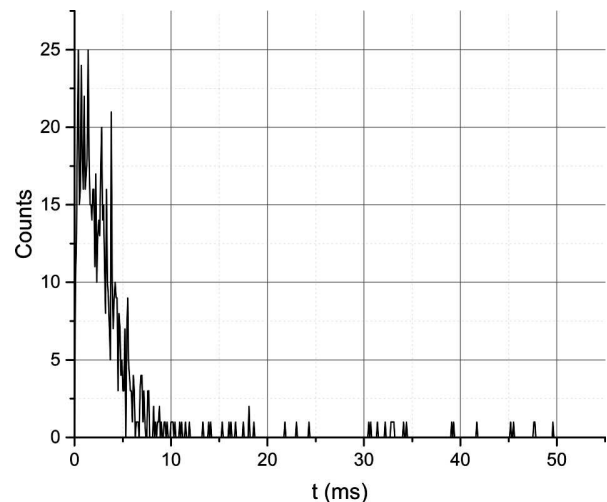

Fig. 20. Pulse response of CFUF54 detectors for 30 loaded fuel assemblies (40000 electron pulses with 35 mA pulse current)

CFUF54 and CFUF34 detectors for further measurements the values of discrimination voltage were selected as 0.64 V, 0.69 V and 0.63 V for H(4), H(2) and H(6) detectors correspondingly. Such values of discrimination voltage provide the ratio CFUF54 and CFUF34 detector counts equal to 10^{-2} with 0.6 V discrimination voltage for L(3), L(1), L(5) detectors, that corresponds to difference in detectors sensitivity.

Fig. 20 shows H(4), H(2) and H(6) detectors pulse responses for the case of 30 loaded fuel assemblies. As it can be seen from the figure, statistics does not pro-

vide accurate measurements of reactivity and k_{eff} but preliminary estimations can be performed. Tabl. 5 shows the results of several measurement sessions of 40 000 electron pulses and 35 mA pulse current with different discrimination voltages. Despite poor statistics for the CFUF54 detectors, the results of reac-

Table 5. Comparison of k_{eff} and reactivity values measured with CFUF34 (L) and CFUF54 (H) detectors for different values of discrimination voltage U_{disc} with 30 loaded fuel assemblies

#	Detector	U_{disc} , V	Reactivity, %		k_{eff}	
			Simul.	Meas.	Simul.	Meas.
1	L(3)	0.42		-21.68		0.860
	L(1)	0.4	-21.4	-21.85	0.862	0.859
	L(5)	0.43		-21.34		0.862
	H(4)	0.6		-21.73		0.860
	H(2)	0.6	-21.4	-21.84	0.862	0.860
	H(6)	0.6		-20.31		0.868
2	L(3)	0.42		-21.67		0.861
	L(1)	0.4	-21.4	-21.85	0.862	0.859
	L(5)	0.43		-21.25		0.863
	H(4)	0.6		-21.67		0.860
	H(2)	0.6	-21.4	-21.7	0.862	0.859
	H(6)	0.6		-21.67		0.862
3	L(3)	0.46		-21.81		0.860
	L(1)	0.44	-21.4	-21.89	0.862	0.859
	L(5)	0.47		-21.3		0.863
	H(4)	0.6		-22.28		0.857
	H(2)	0.6	-21.4	-20.93	0.862	0.865
	H(6)	0.6		-21.11		0.864
4	L(3)	0.46		-21.88		0.859
	L(1)	0.44	-21.4	-21.97	0.862	0.859
	L(5)	0.47		-21.39		0.862
	H(4)	0.6		-20.51		0.867
	H(2)	0.6	-21.4	-21.14	0.862	0.862
	H(6)	0.6		-21.85		0.860
5	L(3)	0.46		-21.67		0.861
	L(1)	0.44	-21.4	-21.89	0.862	0.859
	L(5)	0.47		-21.30		0.863
	H(4)	0.6		-21.66		0.861
	H(2)	0.6	-21.4	-21.78	0.862	0.860
	H(6)	0.6		-20.80		0.865

tivity and k_{eff} measurements are quite similar. The results of measurements can be considered as qualitative evaluation of the measured values.

9. Reactivity Measurement Result Analysis

During the first stage of the NSC KIPT SCA “Neutron Source” physical start-up, in addition to the measurements of neutron physical characteristics of the facility, the thorough measurements of radiation background at the biological shield perimeter were performed. Simultaneously, the readings of the stationary detectors of automatic system of radiation monitoring were registered. The content of air and water in special ventilation system and sewage system was monitored. After each fuel loading step, the probe of water was taken from the primary loop of the SCA to check the water content and confirm leak tightness of the loaded fuel assemblies.

Results of the measurements and parameter monitoring during the first stage of the NSC KIPT SCA “Neutron Source” physical start-up show the following:

1. Measured with two methods values of neutron multiplication factor k_{eff} and reactivity ρ are in agreement with design values for the facility at each step of the fuel loading and corresponds to the values put in the facility “Program of physical start-up”.

2. The value of the fuel assembly critical number in the core obtained with neutron multiplication method (42 units) exceeds the design number (38 units). That increases the reliability of nuclear safety during further fuel loading.

All mentioned above allow to make conclusion about correspondence of the NSC KIPT SCA “Neutron Source” physical start-up progress to the program of the facility start-up. The possibility of the safe continuation of the facility start-up and further fuel loading is guaranteed.

10. Conclusions

The physical start-up of the NSC KIPT SCA Neutron Source has been started. At present, 30 fuel assemblies were loaded in the facility core with measurement of reactivity and k_{eff} at each step of the fuel loading. In accordance with the program of the physical start-up the reactivity measurements were performed with linear accelerator 20 Hz repetition rate and about 35 mA pulse current that corresponds

of about 175 W of average electron beam power. The measurements were performed with two methods: neutron multiplication and area-ratio. The flux-to-current ratio on-line reactivity monitoring method was tested. The results of the reactivity and k_{eff} measurements are in a good agreement with MCNPX code simulation results and mismatching of the simulation and measurement results is decreasing with increasing of the loaded fuel assembly number.

We express our thanks to ANL, Chicago, USA for its efforts on simulation of physical processes in NSC KIPT SCA "Neutron Source" and personally to Dr. Y. Gohar (ANL, USA) and Dr. I. Bolshinsky (INL, USA) for the fruitful discussions during the facility design and development, also for the support of the facility construction and commissioning.

1. O. Bezditko, V. Ivashchenko, I. Karnaukhov, A. Mytsykov, A. Reuzayev, A. Zelinsky. *Conf. Proc. IPAC'2013, 12–17 May, 2013, Shanghai, China*, 3481 (2013) [ISBN: 978-3-95450-122-9].
2. G.W. McKinney, J.W. Durkee, J.S. Hendricks, M.R. James, D.B. Pelowitz, L.S. Waters. MCNPX 2.5.0 – new features demonstrated. *Los Alamos National Laboratory report LA-UR-04-8695*, 14 (2005).
3. Y. Gohar, I. Bolshinsky, D. Naberezhnev, J. Duo, H. Belch, J. Bailey. Accelerator-driven subcritical facility: Conceptual design development. *Nucl. Instr. Meth. Phys. Res. A* **562**, 870 (2006).
4. YunLong Chi *et al.* *Conf. Proc. IPAC'2013, 12–17 May, 2013, Shanghai, China*, 3121 (2013) [ISBN: 978-3-95450-122-9].
5. A. Zelinsky, I. Karnaukhov. *Conf. Proc. IPAC'2011, 4–9 September, 2011, San Sebastian, Spain*, 1084 (2011).
6. DDN 39-6-002, Physical start-up program, Kharkov, 98 (2018) [in Russian].
7. E. Greenspa. The source-multiplication method for absolute reactivity determination. *J. Nucl. Energy* **27**, 129 (1973).
8. Y. Gohar, Y. Cao, Z. Zhong. Measuring and monitoring KIPT Neutron Source Facility Reactivity. *ANL report ANL 15/15*, 68 (2015).
9. A.P. Bezditko, A.N. Gordienko, P.I. Gladkikh, A.M. Gvozd, D.A. Kapliy, I.M. Karnaukhov, I.I. Karnaukhov, V.N. Lyashchenko, A.O. Mytsykov, M.P. Moisieienko, V.E. Rudenko, A.V. Ryezayev, D.V. Tarasov, V.I. Trotsenko, A.Yu. Zelinsky. 100 MeV/100 kW accelerator adjustment for the NSC KIPT neutron source physical start up. *Problems of Atomic Science and Technology* **5** (129). Series: Nuclear Physics Investigations (74), 135 (2020).
10. P. Baeten, R. Brissot, Y. Rugama, A. Billebaud, C. Le Brun, E. Liatard, J. Vollaie, C. Destouches. Analytical investigation and experimental application of the source modulation technique to measure ρ/β_{eff} . *Prog. Nucl. Energy* **48** (6), 550 (2006).
11. Y. Gohar, A. Talamo. Neutron detector signal processing to calculate the effective neutron multiplication factor of subcritical assemblies. *ANL report ANL 16/14*, 60 (2016).
12. M. Klein, G. Borton. Enhancement of signal-to-noise ratio by continuous averaging: Application to magnetic resonance. *Rev. Sci. Instr.* **34**, 754 (1963).

Received 24.06.21

*О. Бизун, П. Гладких, І. Карнаухов,
В. Лященко, А. Мициков, В. Рідозуб,
В. Селіванов, В. Столін, А. Термичний,
І. Ушаков, А. Зелінський*

МЕТОДИ ВИМІРЮВАННЯ РЕАКТИВНОСТІ ТА ПЕРШІ РЕЗУЛЬТАТИ ФІЗИЧНОГО ПУСКУ ЯДЕРНОЇ ПІДКРИТИЧНОЇ УСТАНОВКИ “ДЖЕРЕЛО НЕЙТРОНІВ”

Викладено методи вимірювання нейтронних фізичних характеристик ядерної підкритичної установки “Джерело нейтронів” ННЦ ХФТІ, що керується лінійним прискорювачем електронів, які застосовуються під час фізичного пуску. Представлено результати вимірювань ефективного коефіцієнта розмноження нейтронів та реактивності. Результати вимірювань порівняно з результатами моделювання на основі коду MCNPX. Проаналізовано результати вимірювань.

Ключові слова: підкритична збірка, коефіцієнт розмноження нейтронів, прискорювальна система, лінійний прискорювач електронів.