M.YU. TROFIMENKO,¹ S.K. ASLANOV,¹ V.P. SMOLYAR²

¹ I.I. Mechnikov National University of Odessa

(2, Dvoryanskaya Str., Odessa 65082, Ukraine; e-mail: trofimenko_mikhail@ukr.net)

² National Polytechnical University of Odessa

(1, Shevchenko Str., Odessa 65044, Ukraine; e-mail: vladimirsmolyar@ukr.net)

STRUCTURAL CHANGES IN THE GAS FLAME UPON THE PULSATING COMBUSTION MODE ONSET

PACS 82.33.Vx

An open household gas flame burning in the air atmosphere is studied. A concept of the stoichiometric ratio is clarified for such system on the basis of the observable closed inner cone formation and the pulsating combustion mode onset. We point out the higher combustion efficiency after the transition to a diluted mixture and the pulsating combustion. We also note that several different parameters may act as the limiting factors under certain oxidant–fuel ratios.

Keywords: pulsating combustion mode, stoichiometric ratio, gas flame.

1. Introduction

The continuously growing industrial production powers and the residential fuel consumption arouse the interest in its efficient use.

Because of the faster heat-mass exchange processes (mixing, evaporation, and combustion intensity), the pulsating combustion mode can yield the higher efficiency of combustion and consequently, a more efficient overall use of fuels (particularly, gaseous fuels) [1–3].

A propane-butane mixture torch is a typical representative of the gaseous flames. An optically registered structural change followed by the pulsating combustion may be observed [4, 5] in flame at a certain oxidant-fuel ratio (an atmospheric air may be used as an oxidant). Such combustion mode is the inherent property of the studied flame.

2. Experiment

We studied the burning of the open laminar ($Re=780$) flame of the premix (fuel – 40% propane, 60% butane;

oxidant–air) above a vertical burner with the forced reactant supply. The combustion took place in the air atmosphere under normal conditions ($t^\circ = 20^\circ \text{C}$; pressure – 768 mm Hg).

All the measurements were performed, by using the experimental setup similar to the one described in [5]. Its diagram is shown in Fig. 1.

Using reductor (12), the gas pressure was set to $1.2 \div 4.5$ atm. The gas flow through a burner was controlled with needle valve (9). The air flow was obtained with the use of compressor (14) and controlled with needle valve (11). Both air and gas were supplied to burner's active volume resulting in a homogeneous premix at the nozzle. The flow of the initial components was measured by the sets of parallel rotameters (both for oxidant (18) and fuel (19)).

The obtained flame had a typical structure of the Bunsen flame and consisted of two cones: external and internal ones. Adjusting the fuel and oxidant flows with needle valves, we obtain a flame with the soft outlines radiating in the yellow-red band. Having fixed the air flow and decreasing the gas flow up to the extinction, we observe the flame shrinkage and its dimming (only the blue light remains). The point of the yellow glow (characteristic of the condensed

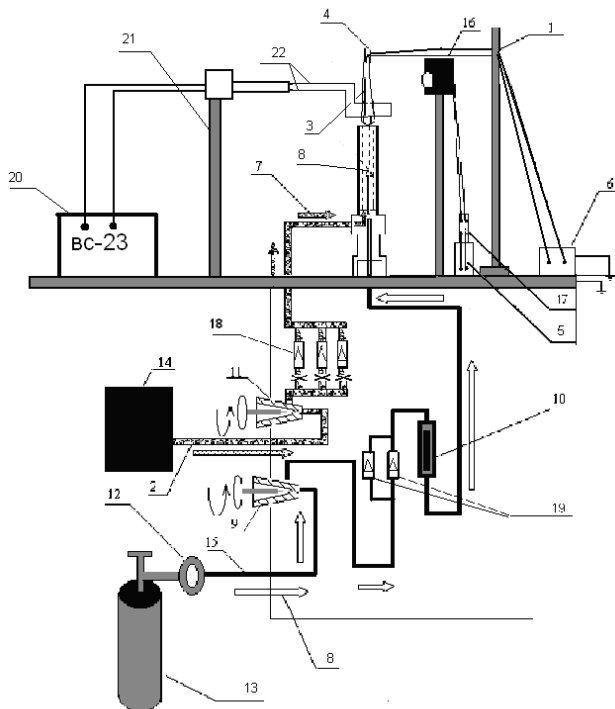

Fig. 1. Experimental setup diagram. 1, 21 – substages; 2, 15 – pipes; 3 – studied flame; 4 – thermojunction inside flame; 5 – “C1-112A” oscilloscope; 6 – “B7-35” voltmeter; 7 – air flow direction; 8 – gas flow direction; 9 and 11 – needle valves; 10 – flame trap (metal chips); 12 – rough-adjustment gas feed reductor; 13 – gas vessel; 14 – compressor; 16 – photodiode; 17 – amplifier; 18 – airflow measuring rotameters; 19 – gas flow measuring rotameters; 20 – “BC-23” high-voltage source; 22 – electrodes

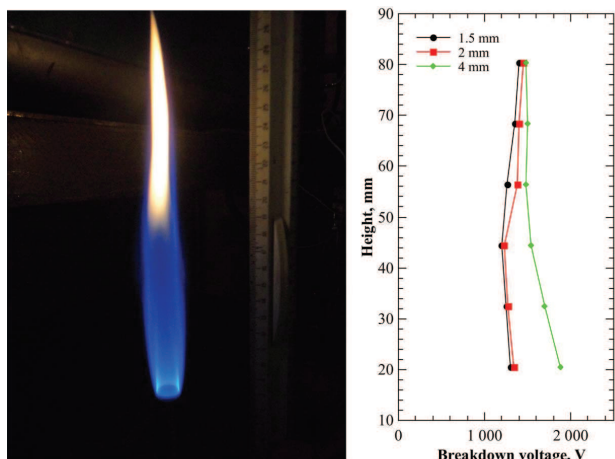

Fig. 2. Photographic image of the enriched mixture flame (left) and the vertical breakdown voltage distribution for different distances between the electrodes (right)

phase) ceasing at the top of the inner cone, according to [6] corresponds to the stoichiometric mixture ratio. The higher and lower percentages of the fuel produce, respectively, the enriched and diluted mixtures. According to [8], it is possible to point three aspects of the presence of charged particles in the flame.

The first one lies in the occurrence of the branching reactions, which depend on the certain conditions in the flame and pass through the stages including many radicals.

The second aspect is related to the sooting conditions. Since all the soot particles (condensed phase) inside the flame are charged, the electrical measurements may be used for the study of burning processes.

The third aspect of the impact of charged particles (particularly, radicals coming from the combustion zone) lies in the pyrolysis and the formation of soot particles.

The described mechanisms lead to the emergence of electrical inhomogeneities at the points of combustion reactions and their influence on the flame itself. The aim of the present research is to use the electrical field as a tool for the flame structure investigation and tracing its changes, when the oxidant-fuel ratio changes.

In our experiment, we measured a change of the breakdown voltage value with the growth of the distance between the electrodes at different heights above the burner jet for different oxidant-fuel ratios. The measurements were performed in the horizontal plane parallel to the burner jet cross-section by changing the distance between the electrodes (0.5 mm platinum wire) symmetrically in both directions from the flame’s symmetry axis. The breakdown moment was registered both visually and using an oscilloscope. The high voltage was supplied from the “BC-23” high-voltage source output used in the 3 kV mode up to the flame breakdown. It is interesting to examine two characteristic cases of the flame structure:

- enriched mixture flame and
- diluted mixture flame.

The image of the enriched mixture burning is given in Fig. 2. The plot shows the vertical distribution of the breakdown voltage values for the distances between the electrodes equal to 1.5, 2, and 4 mm. A similar image for the diluted mixture is given in Fig. 3.

Taking into account the fact that the breakdown voltage depends on a number of factors like the

oxidant-fuel ratio, purity of the gas under study, sequence of the physicochemical reactions, *etc.*, it is necessary to adjust the distance between the electrodes experimentally. However, a balance should be found between the condition of a geometric minimization of the measurement and the breakdown voltage value, under which the leading role would be played by the concentration of charge carriers in the flame and not by the electric field strength. The distance between the electrodes, which satisfies the mentioned conditions, was found to be approximately equal to 2 mm.

For the enriched mixture burning, the breakdown voltage changes smoothly along the vertical axis of the flame. The reaction progresses over a wide zone of the flame (indicated by the lower breakdown voltage). There is no pronounced burning front, and the reactions take place more or less extensively at every point along the flame. The concentration of electrically charged particles changes insignificantly along the flame. Apparently, this is due to the incomplete combustion of the initial components and the formation of charged particles in the condensed phase (yellow light).

On the contrary, there is a distinctive dependence of the breakdown voltage on the height in the diluted mixture flame. The reaction zone (indicated by the lower values of breakdown voltage, and consequently, the higher concentrations of charged particles) is localized at the top of the internal cone and has rather distinguished boundaries. The breakdown voltage remains almost constant with increasing the distance between the electrodes from 1.5 mm to 4 mm over this zone and grows rapidly outside this zone. The growth of the breakdown voltage indicates the absence of electrically charged particles (of the condensed phase as well as free radicals) and, consequently, the termination of the chemical reactions.

It is also interesting to trace the changes of the flame structure while increasing the degree of the mixture dilution. For this purpose, we also measured the vertical distribution of breakdown voltages along the flame's axis for the different mixture compositions.

The obtained results are presented in Fig. 4.

The minimum point of the curves corresponds to the most extensive reactions locations in the flame.

For curve "a" (Fig. 4), such minimum is located at a distance of 30 mm from the burner jet and corresponds to the top of the just formed internal cone.

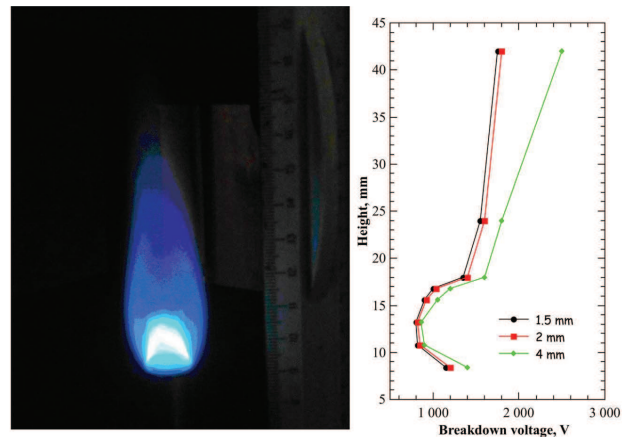

Fig. 3. Photographic image of the diluted mixture flame (left) and the corresponding vertical breakdown voltage distribution for different distances between the electrodes (right)

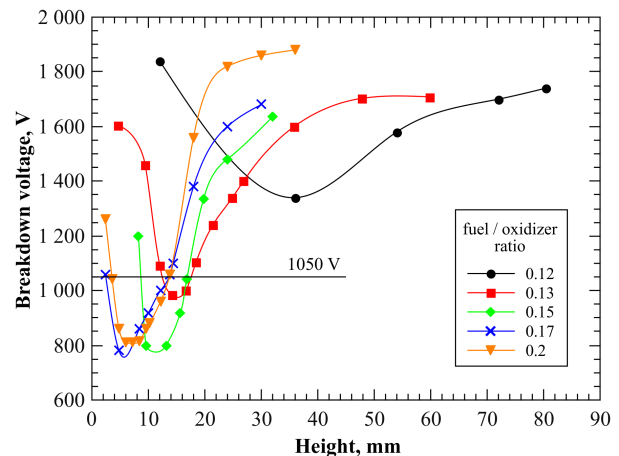

Fig. 4. The breakdown voltage values along the flame's axis depending on the distance between the electrodes for different fuel-to-oxidizer ratios

The position and the extent (linear size along the flame's axis) of the burning zone changes, as the degree of the mixture dilution grows.

For the sake of standardization of the burning zone extent, the measurements were performed for the breakdown voltage value equal to 1050 V.

On the basis of the electrical measurements, one may think of the following flame restructuring scenario. With increasing the mixture dilution, the burning front transforms into a burning zone with its vertical extent growing, the breakdown voltage decreasing, and its base moving closer to the burner jet.

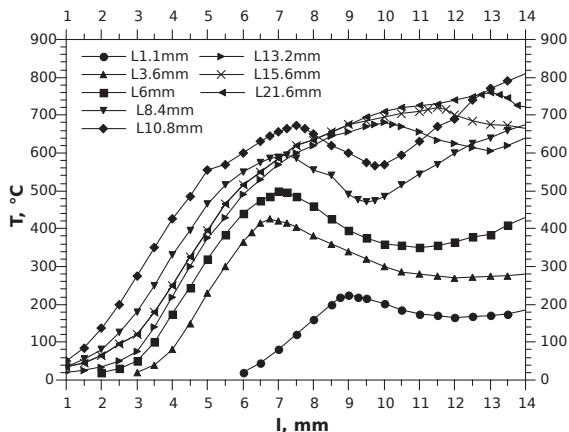

Fig. 5. Temperature distributions in the horizontal cross-sections of the stoichiometric flame at different heights along the flame's axis

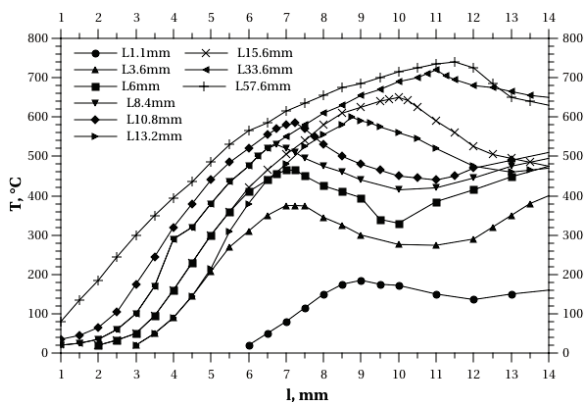

Fig. 6. Temperature distributions in the horizontal cross-sections of the enriched flame at different heights along the flame's axis

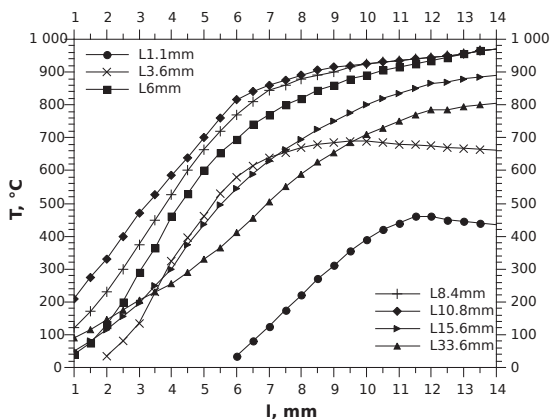

Fig. 7. Temperature distributions in the horizontal cross-sections of the diluted flame at different heights along the flame's axis

Our experimental setup was equipped with a platinum platinum-rhodium thermocouple with a wire diameter of 0.5 mm for the temperature measurements. The thermocouple is fixed inside a ceramic straw on the substage, which makes it possible to move the thermocouple both in horizontal and vertical directions and thus to measure the temperature at any point of the flame. The correctness of such methodology for the inflexible laminar gas flame, in particular, the independence of the results on the radiation energy, was experimentally justified in [7].

The temperature distributions in the horizontal planes at different heights along the flame's axis are shown in Fig. 5.

The results for the enriched flame (similar to the one in Fig. 2) are shown in Fig. 6.

They are also shown in Fig. 7 for the diluted flame (similar to the one in Fig. 3)

These figures show that the horizontal temperature distributions in the enriched (Fig. 6) and stoichiometric (Fig. 5) propane-butane flames pass through some peak values. The exact position of this peak depends on the height above the burner jet. In the case of the diluted mixture (Fig. 7) with the pronounced pulsating combustion mode, the corresponding temperature distributions are monotonous.

Figure 8 shows the positions of the temperature maxima in their respective horizontal cross-sections along the flame's symmetry axis.

The generally accepted gas flame burning mechanism suggested in [6] is as follows. The boundary between the inner and outer cones corresponds to the flame front propagating in the counter-flow of the initial mixture. The outer cone is the area of a redundant fuel (mainly CO and H) and the final combustion of incompletely decomposed initial fuel involving the ambient air diffusion into the reaction zone. The combustion is supported by hot gases and free radicals from the boundary of the inner and outer cones.

As seen from the presented diagrams, the set of maximum temperatures forms the geometric surface similar to the inner cone shape. Apparently, this surface represents the reaction front with the highest combustion efficiency.

When passing from the enriched to the stoichiometric mixture, the closed inner cone is formed (transition from curve "a" to "b" in Fig. 8). Since the moment of the closed inner cone formation and as far as the fuel feed further decreases, the pulsating combus-

tion mode sets and develops [4, 5], by demonstrating the dependence of the frequencies and the amplitudes on the mixture's degree of dilution. The maxima in the temperature distributions gradually fade, and the curves obtain the shape shown in Fig. 7.

Thereby, the fact of the connection between the pulsating combustion mode onset and the closed inner cone formation was experimentally established through the temperature measurements.

3. Results and Discussion

The obtained results give grounds for the assertion that the changes in the flame induced by the transition from the enriched to the diluted mixture are as follows.

The enriched mixture flame (Fig. 2) has the large linear size and is weakly structured. At the relatively low temperatures (Fig. 6), there are electrically charged chemically active particles almost along the whole flame. These particles can propagate beyond the optical boundaries of the flame. The amount of air in the initial mixture is the limiting factor in this case.

The stoichiometric oxidant-fuel ratio may be reached by fixing the air flow and decreasing the gas flow. This also leads to higher temperatures in the flame (Fig. 5) and to the closed inner cone formation accompanied by the pulsating combustion mode onset. The flame structure is determined by the balance of three components in this case: initial air, secondary air, and gaseous fuel. The (ambient) air has a significant impact on the shape of the inner cone.

The further decrease of the gas flow (dilution) leads to a smaller size of the flame (Fig. 3), to the widening of the reactions front (eventually transforming into the reactions zone), and to higher temperatures inside the flame (Fig. 7). The breakdown voltage increases within the outer cone and decreases within the inner cone (Fig. 3). The amplitude and the frequency of optically observed brightness oscillations [5] depend on the oxidant-fuel ratio and the corresponding geometric structure of the flame. The concentration of propane-butane in the initial combustible mixture is the limiting factor in this case.

The suggested "optical" approach to the concept of "stoichiometric ratio" seems reasonable, since it reflects the presence (or absence) of the condensed phase radiation, on the one hand, and the structural

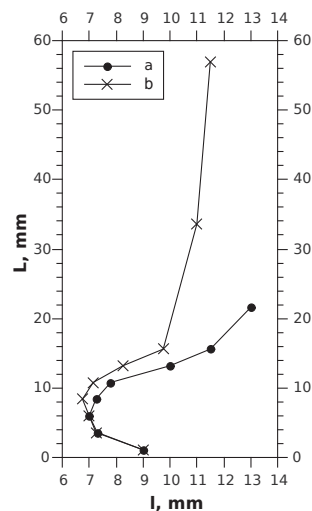

Fig. 8. Positions of the temperature maxima in their respective horizontal cross-sections along the flame's symmetry axis. "a" corresponds to the stoichiometric mixture, "b" – to the enriched mixture

changes in the flame (formation of the closed inner cone) on the other hand.

This approach (if it is possible to introduce the concept of stoichiometric ratio for the organic fuel at all, in view of the ambiguity of the order of intermediate reactions) has some advantage over the calculation of the stoichiometric ratio based on the weight, molecular, *etc.* ratios. This advantage consists in a fact that, in the latter case, it is extremely difficult (or even impossible) to take the secondary (ambient) air into account, which has a considerable impact on the flame structure.

One more parameter difficult to consider properly is the dwelling time of the fuel in the certain zones of the flame, including the preflame preparation, which also determines the combustion efficiency. Nevertheless, by linking it to the parameters available for measurements, we claim that the condition of stoichiometric combustion in our case is met, when there are 600 volume units of air and 140 volume units of propane-butane in the initial mixture.

Therefore, the temperature increases during the transition from the stoichiometric to the diluted mixture. This increases the amount of free radicals supplied by the redundant oxidant and the heat flow in the opposite direction relative to the combustible mixture flow. In turn, it promotes the preflame preparation of the mixture and makes the reactions front

wider, eventually transforming it into a zone. The further dilution of the mixture increases the size of this combustion zone and moves it closer to the burner jet. According to the obtained data (Fig. 4) and the results of [9, 10], the linear size of such zone along the flow may reach 6–8 mm. At the same time, the pulsating combustion mode emerges, the mechanism of which is believed to be determined [5] by the presence of the local volumes with different oxidant-fuel ratios.

4. Conclusions

The performed temperature measurements allow us to make conclusion that the closed inner cone is formed in the flame at the stoichiometric oxidant-fuel ratio and determines the further emergence of the pulsating combustion.

The increase of the mixture dilution leads to the burning front degeneration into a zone, which continues growing in size and moving closer to the burner jet.

The dilution of the initial combustible mixture also yields the higher temperatures and the better pre-flame preparation, by leading to a higher combustion efficiency.

It is shown that a concept of “stoichiometric ratio” may be introduced on the basis of the yellow glow ceasing at the top of the inner cone.

1. B.M. Galitseiskii, Yu.A. Ryzhov, and B.V. Yakush, *Thermal and Hydrodynamical Processes in Oscillating Flows* (Mashinostroenie, Moscow, 1977) (in Russian).
2. V.N. Podymov, V.S. Severyanin, and Ya.M. Shchelokov *Applied Studies of Pulsating Combustion* (Kazan' Univ., Kazan', 1978) (in Russian).
3. V.M. Larionov and R.G. Zaripov, *Oscillations of a Gas in Installations with Combustion* (Kazan' Techn. Univ., Kazan', 2003) (in Russian).

4. M.Yu. Trofimenko, S.K. Aslanov, V.V. Kalinchak, O.N. Zui, and G.M. Oleshko, *Fiz. Aerodisp. Sist.*, Issue 42, 104 (2005).
5. M.Yu. Trofimenko, S.K. Aslanov, and V.V. Kalinchak, in: *Chemical and Radiation Physics*, edited by I.G. Assovskii, A.B. Berlin, G.B. Manelis, and A.G. Merzhanov (Torus Press, Moscow, 2011), Vol. 4 (in Russian).
6. A.G. Gaydon and H.G. Wolfhard, *Flames, Their Structure, Radiation and Temperature* (Chapman and Hall, London, 1960).
7. G.T. Tsygankov, *Fiz. Goren. Vzryva*, No. 3, 54 (1991).
8. J. Lawton and F.J. Weinberg, *Electrical Aspects of Combustion* (Clarendon Press, Oxford, 1969).
9. M.Yu. Trofimenko, S.K. Aslanov, and V.P. Smolyar, *Proceed. of the 3-rd Intern. Conference on the Physics of Dusty and Burning Plasmas* (Odessa, 2010), p. 135 (in Russian).
10. M.Yu. Trofimenko, S.K. Aslanov, V.V. Kalinchak, V.P. Smolyar, and G.A. Tishchenko, *Proceed. of the XXIV Sci. Conference of CIS countries “Disperse Systems”* (Astroprint, Odessa, 2010), p. 292 (in Russian).

Received 28.11.13

М.Ю. Трофименко, С.К. Асланов, В.П. Смоляр

СТРУКТУРНІ ЗМІНИ ГАЗОВОГО ФАКЕЛА ПРИ НАСТАННІ ПУЛЬСАЦІЙНОГО РЕЖИМУ ГОРІННЯ

Резюме

Розглядається горіння відкритого факела суміші побутового газу із повітрям у повітряній атмосфері. Уточнено поняття стехіометричного співвідношення для такої системи, що пов'язане, зокрема, із утворенням замкненого внутрішнього конуса та настанням пульсаційного режиму горіння. Звертається увага на підвищення повноти згорання під час переходу до збідненої суміші та пульсаційного режиму горіння. Зазначається також, що за різних співвідношень окисник–паливо у факелі (а отже і різних структурах факела) лімітуючим компонентом можуть виступати різні комбінації суміші “пропан–бутан – внутрішній (первинний) окислювач вихідної суміші – зовнішнє (вторинне, атмосферне) повітря”.