<https://doi.org/10.15407/ujpe63.2.110>

I.V. LITOVKO,¹ A.N. DOBROVOLSKY,² L.V. NAIKO,² I.V. NAIKO²

¹Institute for Nuclear Research, Nat. Acad. of Sci. of Ukraine

(47, Prosp. Nauky, Kyiv 03680, Ukraine; e-mail: ilitovko@rambler.ru)

²Institute of Physics, Nat. Acad. of Sci. of Ukraine

(46, Prosp. Nauky, Kyiv 03028, Ukraine)

A NEW TYPE OF PLASMA ACCELERATOR WITH CLOSED ELECTRON DRIFT

A new type of plasma accelerator with closed electron drift and open walls has been studied further. In particular, the current-voltage characteristics in various operation modes are obtained. Two operation modes, low- and high-current ones, with specific parameters are revealed. To make the earlier proposed physical-mathematical model more adequate to the experiment, a hybrid model, in which the dynamics of neutrals and ions is described by kinetic equations, is applied. The distribution of the electric potential in the accelerating gap is numerically obtained. An insignificant difference between the potential distributions in the hydrodynamic and hybrid models consisting in higher potential gradients in the hybrid model is found.

Keywords: plasma accelerator, closed electron drift, Hall-type accelerator, hydrodynamic model, hybrid model.

1. Introduction

Accelerators with closed electron drift and open (gas) walls have not been studied so extensively as the well-known and widely applied plasma accelerators with anode layer and accelerators with closed electron drift and dielectric walls [1]. However, the accelerators of this type may be of interest for generating a flux of charged particles with various currents and minimum impurities of an electrode material. They can also be attractive as a prototype for low-cost ionic rocket engines [2].

Accelerators with closed electron drift and open (gas) walls have a number of advantages. In particular:

1. Minimization of solid walls results in a lower content of a wall material in the ionic beam. At the same time, the minimum curvature of magnetic power lines remains preserved.

2. Minimization of walls favors the preservation of the electron dynamics in the plasma medium, because conditions for the formation of secondary electrons by the emission from the plasma accelerator walls are reduced to the minimum.

2. Experimental Part

Experiments were carried out on a laboratory stand at the Institute of Physics of the National Academy of Sciences of Ukraine. The schematic diagram of the stand is shown in Fig. 1.

Vacuum chamber 1 contained a test mockup of the accelerator with open walls. The accelerator consisted of a magnetic core with permanent magnets 2 and an electrode system with cylindrical anode 3 and cathode 4 formed by a system of pins. The experimental installation allowed a controlled gas input, by using a CHA-2 system. The gas pumping was performed with the use of a vacuum unit with an oil-vapor pump.

The experimental model of the accelerator had the following characteristics: the cylindrical cooled

© I.V. LITOVKO, A.N. DOBROVOLSKY, L.V. NAIKO,
I.V. NAIKO, 2018

copper anode had a diameter of 6.7 cm, the cathode pins were arranged in a circle and equidistantly from system's axis. The pin positions could be varied by changing the circle diameter and the anode-to-cathode distance. The latter could be varied from 1 to 3.5 cm.

A system of permanent magnets created a magnetic field of 650–750 Oe. The anode voltage was up to 2.5 kV, and the working gas pressure was in the interval 10^{-5} – 10^{-3} Torr. The system of permanent magnets was arranged in such a way that the magnetic field in the gap between the cathode and the anode was parallel to system's axis as much as possible. It was owing to this configuration of the magnetic field that a system with open walls was created.

The working gas in the system was argon. In the course of the experiment, the chamber was filled with the working gas. The anode was supplied by a voltage of up to 2.5 kV obtained from a power source, and the cathode was grounded. A self-consistent distribution of the potential emerged between the electrodes, which resulted in the generation of a plasma and its acceleration.

3. Experimental Results

First, the dependences of the current density on the working gas pressure were measured. In general, the operation modes of this accelerator are very similar to those of an accelerator with anode layer. In particular, the appearance of a well-distinguishable narrow emitting layer between the anode and cathode was observed at about 10^{-4} Torr, which was characterized by low discharge currents. As the pressure was increased, this layer expanded over the whole accelerator volume, and a bright radiation emission from the accelerator volume through the ends of the cylindrical canal along the cylindrical symmetry axis was observed. In this mode, the discharge current was up to 2 A. The results concerning the influence of the working gas pressure in the source volume on the discharge current density in the low-current mode are shown in Fig. 2.

The curves measured at various (up to 1.5 kV) voltages applied across the discharge gap make it evident that the current weakly depends on the gas pressure in the system in the measured pressure interval. This result is explained by the fact that the concentration of ionized particles under experimental conditions was almost independent of the working gas pres-

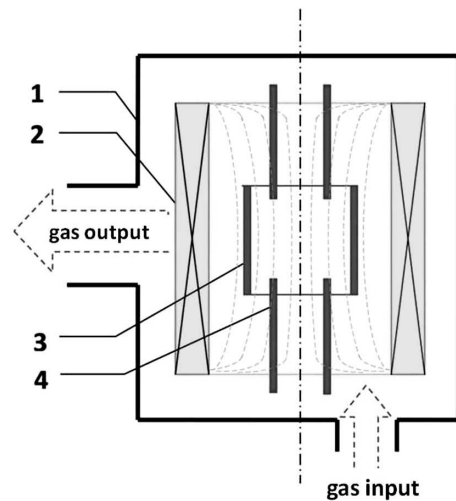

Fig. 1. Experimental setup; vacuum chamber (1), magnetic system ($H = 650$ – 750 Oe) (2), anode (3), cathode (4)

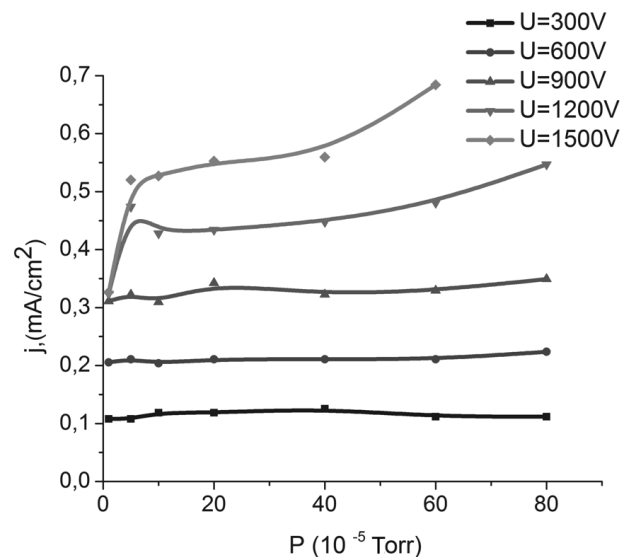

Fig. 2. Dependences of the discharge current density on the working gas pressure for various voltages across a discharge gap in the low-current mode

sure. This conclusion also corresponds to our theoretical results obtained earlier [2].

Figure 3 exhibits the accelerator current-voltage characteristics (CVCs) with high-current sections. It is evident that the transition into the high-current mode occurs under the action of two factors: the working gas pressure and the voltage applied across the discharge gap. In a certain voltage interval, we obtained the low-current mode (Fig. 4). Ordinary lin-

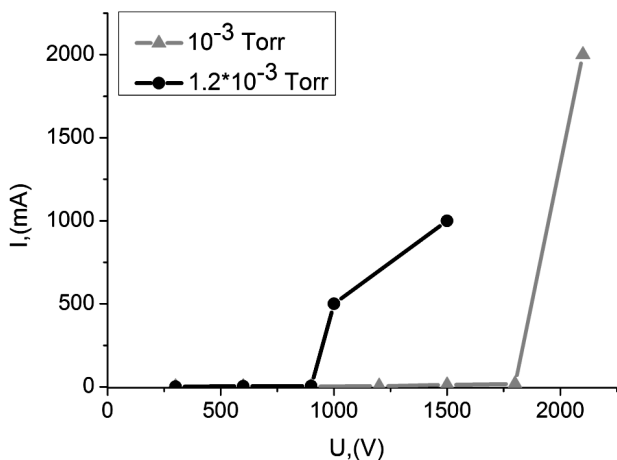

Fig. 3. CVCs of the accelerator for various working gas pressures in the high-current mode

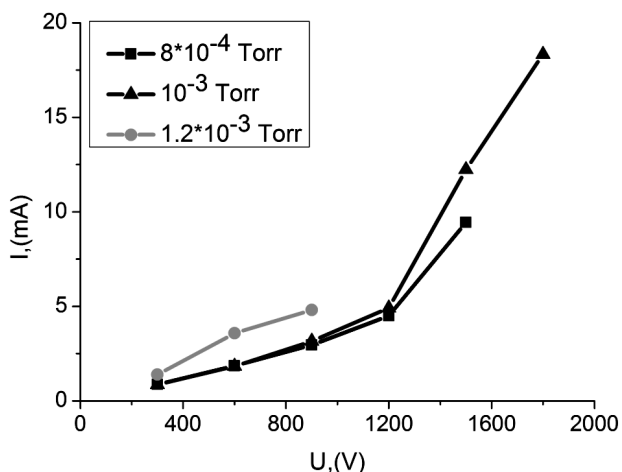

Fig. 4. CVCs of the accelerator for various working gas pressures in the low-current mode

ear characteristics are typical of this mode. When the voltage reached a certain value, the discharge current increased in a jump-like manner, and the discharge transited into the high-current mode, in which the distinct anode layer was absent. In this mode, a typical discharge current was several orders of magnitude higher (up to 2 A) than in the low-current mode.

Another characteristic feature of the high-current mode is the formation of a plasma torch (Fig. 5). In the discharge concerned, ions are accelerated along system's radius toward system's axis. The torches at the ends, on the contrary, are observed along the axis, perpendicularly to the radius and the direction of initial ion acceleration. Owing to the discharge geome-

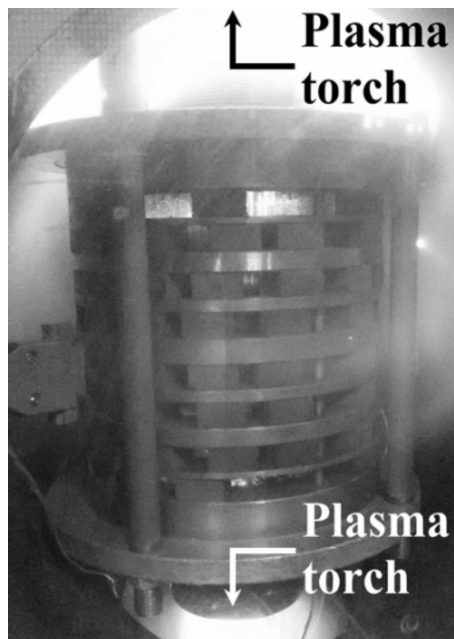

Fig. 5. Image of the accelerator operating in the high-discharge mode. Plasma torches are visible at system's ends

try, a large fraction of generated ions escape from the system perpendicularly to its radius. That is why well noticeable plasma torches are formed in the high-current mode. Our earlier results testify that, under certain conditions, a potential drop can emerge along the plasma torch axis [2]. This effect can be used to accelerate a beam of charged particles.

4. Theoretical Model and Its Results

In order to explain the obtained experimental data, a one-dimensional theoretical model was developed (Fig. 6). It is based on hydrodynamic equations. In the framework of this model, both exact analytical and numerical solutions were obtained [2, 3].

Nevertheless, although the hydrodynamic model can well describe the dynamics of the electron and ionic components, it does not make allowance for ionization processes, as well as the influence of neutral atoms in the working gas. A purely kinetic description cannot also be used because of a significant difference between the velocities of electrons and ions. Therefore, a description using the hybrid model may be an optimal solution. In the framework of this model, the hydrodynamic description is used for the electron component, and the kinetic description for the ionic

and neutral ones. This approach also allows the limited stay time of ions in the system to be taken into account.

As was done earlier [2, 3], a one-dimensional model was considered with regard for only the single ionization. In this case, we can write the following equations for neutrals and ions, respectively:

$$\frac{\partial f_0}{\partial t} + \nu_0 \frac{\partial f_0}{\partial x} = -\langle \sigma_{ie} \nu_e \rangle n_e f_0, \quad (1)$$

$$\frac{\partial f_i}{\partial t} + \nu_i \frac{\partial f_i}{\partial x} + \frac{e}{M} E \frac{\partial f_i}{\partial v} = \langle \sigma_{ie} \nu_e \rangle n_e f_0, \quad (2)$$

where n_e is the electron concentration, and f_0 and f_i are the distribution functions for neutrals and ions, respectively, which satisfy the following boundary conditions:

$$f_0(0, v, t) = \left(\frac{M}{2\pi T} \right)^{3/2} \exp\left(-\frac{Mv^2}{2T}\right), \quad (3)$$

$$f_i(0, v, t) = 0. \quad (4)$$

The right-hand sides of Eqs. (1) and (2) are different only in the sign. They describe the recession of the neutral component in Eq. (1), and the growth of the ionic component in Eq. (2).

For the right-hand sides of Eqs. (1) and (2), we may write

$$\langle \sigma_{ie} \nu_e \rangle = \sigma \nu_e(T_e) \exp\left(-\frac{U_i}{T_e}\right), \quad (5)$$

where σ is the maximum ionization cross-section, T_e the electron temperature, $\nu_e(T_e)$ the average heat velocity of electrons, and U the ionization potential. In those notations, the ion concentration n_i and the ion current density j_i are expressed as follows:

$$n_i = \int f_i dv, \quad (6)$$

$$j_i = \int v f_i dv. \quad (7)$$

Again, we proceed from the statement that the total current in the system is equal to the discharge current,

$$j_d = j_i + j_e, \quad (8)$$

where the electron current density

$$j_e = \mu \left(en_e E - \frac{\partial n_e T_e}{\partial x} \right). \quad (9)$$

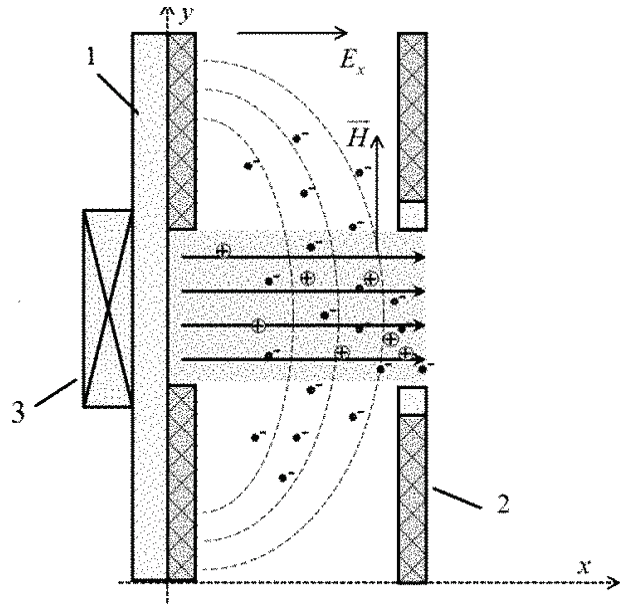

Fig. 6. Plasma accelerator model: anode (1), cathode (2), magnetic system (3). Dashed curves denote power lines of the magnetic field. Arrows indicate the ion acceleration direction

Here, $\mu = ev_e / (m\omega_{eH}^2)$ is the electron mobility, and E the electric field strength. Assuming that electrons lose their energy mainly due to collisions of various types and denoting the characteristic time of temperature recession as a result of collisions by τ_0 , the following expression can be written for the temperature evolution:

$$T_e = j_d E \tau_0 \left(1 - e - \frac{t}{\tau_0} \right) / en_e. \quad (10)$$

In the stationary state,

$$T_e = j_d E \tau_0 / en_e. \quad (11)$$

Then expression (9) can be rewritten in the form

$$j_e = \mu \left(en_e E - j_d \tau_0 \frac{\partial E}{\partial x} \right). \quad (12)$$

Adding the Poisson equation

$$\frac{\partial E}{\partial x} = 4\pi e (n_i - n_e), \quad (13)$$

we obtain a closed system of equations describing the system.

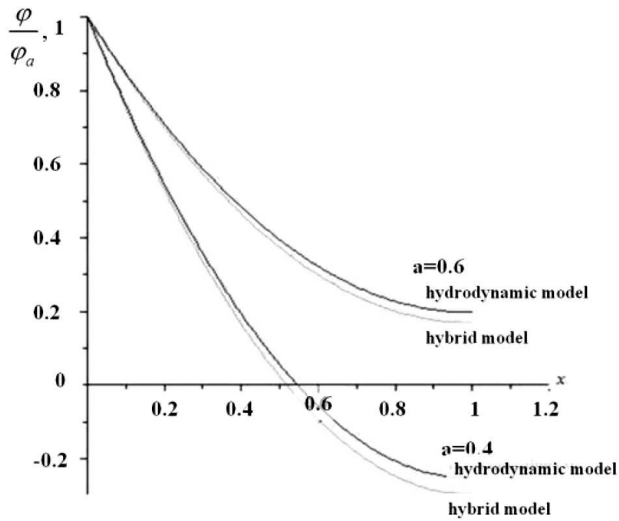

Fig. 7. Comparison between the results of numerical calculations for the potential distribution in the discharge gap in the hydrodynamic and hybrid models

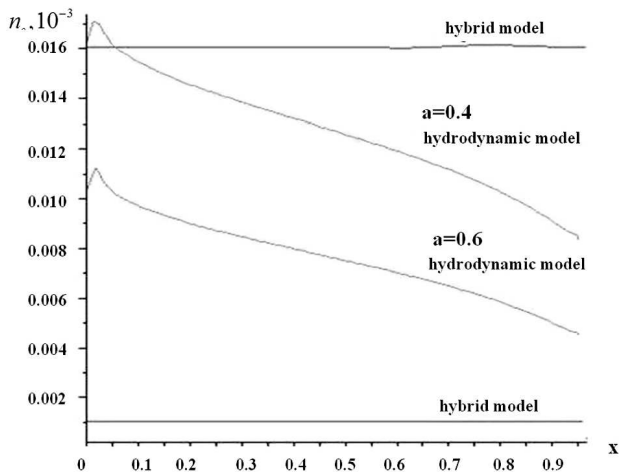

Fig. 8. Comparison between the results of numerical calculations for the electron concentration in the discharge gap in the hydrodynamic and hybrid models

This model was used to numerically calculate the distributions of electric potential and electron concentration in the accelerating gap (see Figs. 7 and 8, respectively). The calculations were continued until the system reached a stationary state. In order to compare the results obtained in the hybrid and hydrodynamic models, the same parameters were used for both models. As was mentioned in works [2, 3], the potential drop in the accelerating gap can be com-

plete, incomplete, or exceed the applied potential, by depending on the physical parameters of the system, which are described by the parameter $a = \frac{\mu\tau_0\phi}{d^2}$ in the hydrodynamic model. In particular, the optimal mode, when the potential drop in the gap is complete, is realized at $a = 0.5$. At $a > 0.5$, the potential drop is incomplete, and at $a < 0.5$ the potential drop exceeds the applied potential.

From Fig. 7, one can see that, for the potential distribution, there is a slight difference between the hydrodynamic and hybrid models in all cases. Concerning the electron concentration (Fig. 8), its behavior, at first glance, is different in two models: in the stationary state, it is almost constant across the gap in the hybrid model and slightly changes in the hydrodynamic one. However, a detailed analysis shows that, qualitatively, the profiles of the electron concentration curve in the hybrid and hydrodynamic models are similar, whereas the corresponding variation across the gap in the hybrid model is even smaller than in the hydrodynamic one. Thus, the hydrodynamic model describes the examined system rather well. Its advantages include a possibility to obtain exact analytical solutions.

5. Conclusions

Our research of the accelerator with closed electron drift and open walls demonstrates its similarity to the accelerator with anode layer and metallic walls in the accelerator channel. The low-current operation mode with an anode layer confined by the interelectrode gap and the high-current operation mode with well-distinguishable plasma torches at system's ends are obtained. The jump-like transition between the modes is shown to occur under the influence of the anode potential and the working gas pressure. In the low-current mode, the discharge current depends much stronger on the voltage applied across the discharge gap than on the working gas pressure. A hybrid theoretical model was developed, and simulation results on its basis are obtained. A comparison between the results of both models obtained in model experiments testifies to an insignificant influence of the neutral component of a working gas on the formation of the potential drop across the discharge gap for the examined initial conditions.

The authors express their gratitude to O.A. Goncharov for the idea of this work, useful advice, and discussions both in the course of researches and when writing the paper. The work was partially supported by the National Academy of Sciences of Ukraine (grants Nos. 34-08-15 and PL-15-32).

1. A.I. Morozov. *Introduction to Plasma Dynamics* (CRC Press, 2012).
2. A.A. Goncharov, A.N. Dobrovolsky, I.V. Litovko, L.V. Naiko, I.V. Naiko. Plasma accelerator with closed electron drift and open walls. *Vopr. At. Nauki Tekhn.* No. 4, 26 (2015).
3. A.A. Goncharov, A.N. Dobrovolsky, I.V. Litovko, L.V. Naiko, I.V. Naiko. Novel modification of Hall-type ion source (study and the first results). *Rev. Sci. Instrum.* **87**, 02A501 (2016).

Received 19.11.15.

Translated from Ukrainian by O.I. Voitenko

I.V. Литовко, А.М. Добровольський,
Л.В. Найко I.V. Naiko

НОВИЙ ТИП ПЛАЗМОВОГО
ПРИСКОРЮВАЧА ІЗ ЗАМКНЕНИМ
ДРЕЙФОМ ЕЛЕКТРОНІВ

Резюме

Проведено подальше дослідження плазмового прискорювача нового типу із замкненим дрейфом електронів та відкритими стінками. В ході лабораторного експерименту отримано вольт-амперні характеристики прискорювача в різних режимах роботи. Виявлено два режими роботи: слабко-струмовий та сильнострумовий, які мають свої особливості. З метою наближення запропонованої раніше фізико-математичної моделі до експерименту було здійснено перехід до гібридної моделі, в якій динаміка нейтральної компоненти та іонів описується кінетичними рівняннями. З використанням запропонованої моделі було чисельно отримано розподіл електричного потенціалу в прискорюючому проміжку. Виявлено незначну різницю для розподілу потенціалу в гідродинамічній та гібридній моделях, яка полягає у більшому градієнті потенціалу для гібридної моделі.