

<https://doi.org/10.15407/ujpe69.5.300>

O.O. BOROVİK^{1,2}

¹ Institute of Electron Physics Nat. Acad. of Sci. of Ukraine

(21, Universytets'ka Str., Uzhhorod 88017, Ukraine; e-mail: baa1948@gmail.com)

² Uzhhorod National University

(54, Voloshina Str., Uzhhorod 88000, Ukraine)

EXCITATION DYNAMICS OF THE 5p⁶ AUGER SPECTRA IN Ba + e⁻ COLLISIONS

The ionization of the 5p⁶ subshell in Ba atoms has been studied in an electron-impact energy range 23–105 eV by measuring the Auger spectra arising from the decay of the 5p⁵nl n'l' states. The energy dependences of the ionization cross-section have been obtained for nine states in the 5p⁵5d², 5p⁵5d6s and 5p⁵6s² configurations. The analysis of the behavior of the cross-sections made it possible to determine the role of direct and indirect ionization processes involved in the 5p⁶ ionization of the Ba atom.

Keywords: atom, ion, ionization, autoionization, Auger spectra, cross-section.

1. Introduction

Barium, like other alkaline earth elements, is widely used in modern physics to study the properties of ultracold laboratory [1, 2] and astrophysical [3, 4] plasmas. In this regard, studies of the mechanisms of excitation and ionization of electron subshells, the structure of energy levels, their excitation cross-sections, and decay channels are relevant.

Ionization of the 5p⁶ subshell in barium leads to the formation of a large class of ionic states, most of which are located between the second ionization limit and the lower excited levels of the Ba²⁺ ion [5]. The following reactions describe the formation of such levels:

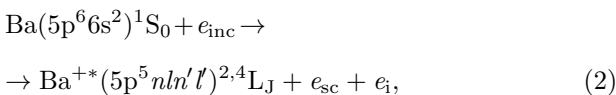
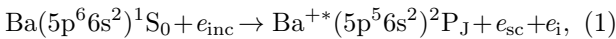

where e_{inc} , e_{sc} , e_i mark, respectively, incident, scattered, and ionization electrons. Reaction (1) describes the ionization of the 5p⁶ subshell with the formation of two doublet states ²P_{3/2,1/2}. Reaction (2) describes the simultaneous ionization of the 5p⁶ subshell and

excitation of the 6s² valence shell (so-called “shake-up” process) with the formation of the (5p⁵nl n'l')^{2,4}L_J satellite states. It is important to note that, for these states, which play an important role in the double ionization of Ba atoms [6, 7], there are yet no data on the cross-sections, and their classification is largely contradictory (see [8–10] and references therein).

The formation of Ba²⁺ ions in the ground state is the only de-excitation channel for 5p⁵nl n'l' states:

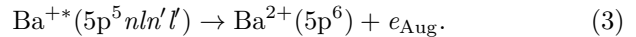

The ejected electrons e_{Aug} form the Auger spectrum in which the intensity of each line is proportional to the cross-section of the corresponding ionic state. The measurements of spectra with appropriate energy resolution over a wide range of impact energies make it possible to obtain the energy dependence of the ionization cross-section. The latter contains direct information about the origin and efficiency of electronic transitions (1) and (2). This technique was used in this work to study the ionization of the 5p⁶ subshell in the Ba atom. The obtained ionization cross-sections for 5p⁵nl n'l' states made it possible to analyze their existing spectroscopic classification and establish their formation mechanisms. In Section 2, the apparatus and the measurement procedure are described. In Section 3, the obtained experimental results and their discussion are presented. Conclusions are drawn in Section 4.

Citation: Borovik O.O. Excitation dynamics of the 5p⁶ Auger spectra in Ba + e⁻ collisions. *Ukr. J. Phys.* **69**, No. 5, 300 (2024). <https://doi.org/10.15407/ujpe69.5.300>.

Цитування: Боровик О.О. Динаміка збудження 5p⁶ Оже спектрів у Ba + e⁻ зіткненнях. *Укр. фіз. журн.* **69**, № 5, 300 (2024).

2. Apparatus and Measuring Procedure

The Auger spectra corresponding to the decay of the $5p^5nl n'l'$ states (see reaction (3)) were measured by employing the electron spectrometer [11] shown schematically in Fig. 1. An electron beam from a five-electrode electron gun 1 was focused onto a barium vapor beam 2 produced by a resistively heated oven operated at a typical temperature of 610–650 °C. The Auger electrons were analyzed by the 127° cylindrical electrostatic analyzer 3 positioned at the “magic” observation angle of 54.7°, at which the detected intensity does not depend on the alignment of the ionic states [12]. At the output of the analyzer, electrons were detected with a channeltron. The incident- and Auger-electron energy resolutions (FWHM) were approximately 0.4 and 0.07 eV, respectively. The uncertainties of the ejected-electron and incident-electron energy scales were ± 0.04 eV and ± 0.1 eV, respectively. During the measurements, the spectrometer chamber was evacuated with a turbo-molecular pump to a base pressure in the range $(1-5) \times 10^{-7}$ Torr.

The spectra were obtained at 23.1, 27.5, 32.5, 53.0, and 105 eV electron impact energies. The spectrum processing procedure included the subtraction of the background intensity and the determination of the line intensity. For the strong lines, the relative uncertainty in determining the intensity generally did not exceed 20%. The line intensity normalized to the current of the primary electron beam determined the excitation cross-section (in relative units) of the corresponding ionic states.

3. Results and Discussion

The examples of the $5p^6$ Auger spectra at 27.5 and 105 eV impact energies are shown in Fig. 2. In the Auger-electron energy range of 5.5–10.0 eV, 40 lines were revealed. A comparison of the spectra shows that, at an impact energy of 27.5 eV, the spectrum is dominated by a group of lines 1–21. With increasing impact energy, the intensity of lines 15, 20, 21, 25, and 36 also increases. In the spectrum at 105 eV, these lines are the most strong. The intensity of line 7 decreases with increasing the impact energy, but in the spectrum at 105 eV, it remains intense.

The ionization cross-sections for the $5p^5nl n'l'$ states, which are represented in the spectra by lines 2, 4, 6, 7, 20, 21, 33, 36, and 40, are shown in Fig. 3. Of the known data on the spectroscopic classification of

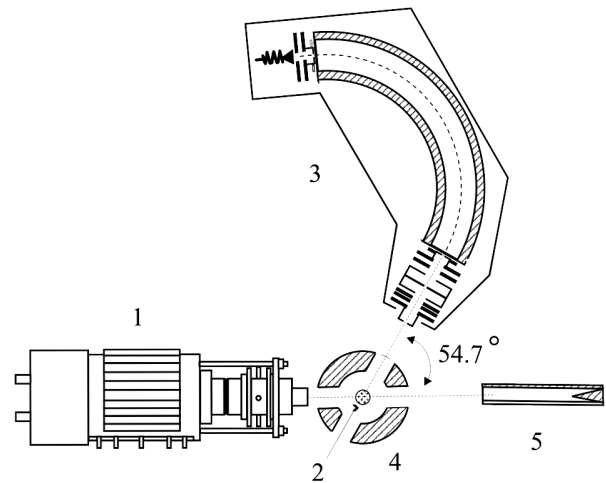

Fig. 1. Auger-electron spectrometer: electron gun (1); atomic beam (2); electron analyzer (3); scattering chamber (4); Faraday cup (5)

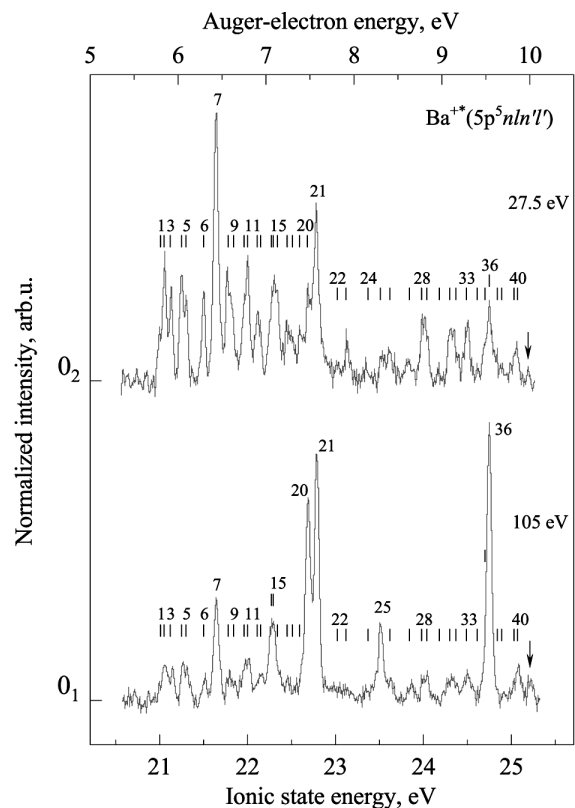

Fig. 2. The $5p^6$ Auger spectra of Ba atoms for impact energies 27.5 eV and 105 eV. In spectra, a polynomial background function was subtracted from the original data. Bars on the top of the spectra mark the positions of Auger lines

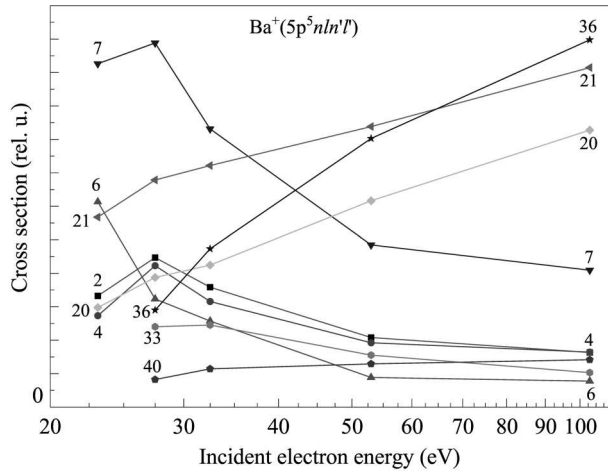

Fig. 3. Ionization cross-sections for the $5p^5nl'n'l'$ states of Ba^+ ions. The numbers correspond to the line number in the spectra

these lines [8–10]; in this work, we used the results obtained in [9], which are currently the most complete. The assignment of lines and energies of the corresponding ionic states are presented in Table.

Two shapes of the cross-sections are observed with maxima at low and high impact energies. As was shown by analyzing the excitation dynamics of the $4p^5nl'n'l'$ states in Sr^+ [13], the first type of cross-sections should reflect the formation of states with a dominant quartet character. However, in our data, this conclusion is consistent only with identifying lines 2 and 4 as the $5p^55d^2(^3F)^4D_{3/2}$ and $5p^55d(^3P)6s^4P_{3/2}$ quartet states. The shape of the cross-sections 6, 7, and 33 contradicts their identification as, respectively, $5p^55d(^3P)6s^2P_{1/2}$,

Spectroscopic assignment [9] and energies E of the $5p^5nl'n'l'$ states in Ba^+

Line	Assignment	E , eV
2	$5p^55d^2(^3F)^4D_{3/2}$	21.05
4	$5p^55d(^3P)6s^4P_{3/2}$	21.25
6	$5p^55d(^3P)6s^2P_{1/2}$	21.50
7	$5p^55d(^3P)6s^2P_{3/2}$	21.64
20	$5p^56s^2(^1S)^2P_{3/2}$	22.68
21	$5p^5(6s^2(^1S)^2P_{3/2} + 5d^2(^3F)^4F_{3/2})$	22.78
33	$5p^55d(^1D)6s^2D_{5/2}$	24.49
36	$5p^56s^2(^1S)^2P_{1/2}$	24.75
40	$5p^5(5d^2(^3P)^2S_{1/2} + 5d^2(^3P)^2D_{5/2})$	25.07

$5p^55d(^3P)6s^2P_{3/2}$, and $5p^55d(^1D)6s^2D_{5/2}$ doublet states. On the one hand, that may indicate the mixture of these states with quartets. The known calculations [9, 10] show that this effect is strong in the excitation-ionization of the $5p^6$ subshell of Ba atoms. On the other hand, as is shown below, the two-step autoionization as an indirect ionization process is the most probable reason for increasing the cross-sections at low impact energies.

Lines 20, 21, 36, and 40 represent the second group of cross-sections with maxima at high impact energies. Lines 20, 21, and 36 reflect the direct ionization of the $5p^6$ subshell by forming the $5p^56s^2\ ^2P_{1/2,3/2}$ doublet states (see reaction (1)). The rapid increase in cross-sections 20 and 21 at low impact energies may reflect the presence of a quartet component, as is the case for state 21 (see Table). However, another and more probable reason for this behavior may be the indirect ionization of the $5p^6$ subshell, namely, the two-step autoionization with the participation of the $5p^5nl'n'l'n''l''$ high-lying atomic autoionizing states:

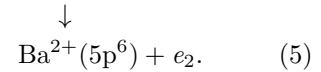
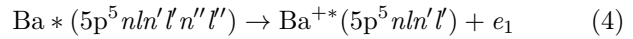

The spectroscopic assignment and the analysis of the decay channels of the $5p^5nl'n'l'n''l''$ states in Ba atoms [14] have shown that reaction (4) is the most preferred channel for the decay of atomic states with excitation thresholds above 21 eV. Their resonant excitation character [15] explains the rapid increase in the ionization cross-sections at threshold energies.

Since reaction (4) is most effective in populating low-lying ionic states, its contribution to their cross-section should be especially noticeable. That is demonstrated by the ionization cross-sections for low-lying doublet states $5p^55d(^3P)6s^2P_{1/2}$ (line 6) and $5p^55d(^3P)6s^2P_{3/2}$ (line 7). As can be seen from Fig. 3, the cross-sections of these states at an impact energy of 27.5 eV exceed those at an energy of 105 eV by approximately 8 and 3 times, respectively. For the higher-lying doublet $5p^55d(^1D)6s^2D_{5/2}$ (line 33) contribution from the two-step autoionization is much smaller and is completely absent for the high-lying doublets $5p^56s^2(^1S)^2P_{1/2}$ (line 36) and $5p^55d^2(^3P)^2S_{1/2} + 5p^55d^2(^3P)^2D_{5/2}$ (line 40). There is also no contribution from the two-step autoionization for the lowest-lying quartet states

$5p^5 5d^2(^3F)4D_{3/2}$ (line 2) and $5p^5 5d(^3P)6s^4 P_{3/2}$ (line 4). Interestingly, a similar observation was previously made, when studying the ionization of the $4p^6$ shell in Sr atoms [13].

4. Conclusions

In this paper, we present our first data on the ionization cross-sections of the $5p^5 nln'l'$ states in Ba^+ ion. The data were obtained in the range of electron impact energies 23-105 eV by measuring the Auger spectra arising from the decay of the $5p^5 nln'l'$ states. The energy behavior of the cross-sections made it possible to analyze the role of direct and indirect processes in the electron-impact ionization of the $5p^6$ subshell in Ba atoms. In particular, for doublet states, it is shown that the two-step autoionization, as an indirect ionization process, dominates at low impact energies, and direct $5p^6$ ionization dominates at high impact energies. For quartet states, the influence of the two-step autoionization is not observed.

The obtained results show the need to study the ionization of the $5p^6$ subshell at low impact energies to detect the post-collision interaction effect and study the behavior of the ionization cross-sections near the threshold. Theoretical calculations in barium and other alkaline-earth atoms would also be desirable.

This work was funded by the National Academy of Sciences of Ukraine through Project No. 0124U000741 and by the Ministry of Education and Science of Ukraine under Project No. 0118U000173.

1. F. Calegari, G. Sansone, S. Stagira, C. Vozzi, M. Nisoli. Advances in attosecond science. *J. Phys. B: At. Mol. Opt. Phys.* **49**, 062001 (2016).
2. I. Courtillot, A. Quessada-Vial, A. Bruschi, D. Kolker, G.D. Rovera, P. Lemonde. Accurate spectroscopy of Sr atoms. *Eur. Phys. J. D* **33**, 161 (2005).
3. A. McWilliam, G.W. Preston, C. Sneden, L. Searle. Spectroscopic analysis of 33 of the most metal poor stars. II. *Astron. J.* **109**, 2757 (1995).
4. F. Rizzuti, G. Cescutti, F. Matteucci, A. Chieffi, R. Hirschi, M. Limongi. The contribution from rotating massive stars to the enrichment in Sr and Ba of the Milky Way. *Mon. Not. R. Astron. Soc.* **489**, 5244 (2019).
5. D. Rassi, K.J. Ross. The ejected-electron spectrum of barium vapour autoionising and Auger levels excited by 20–

- 500 eV electrons. *J. Phys. B: Atom. Molec. Phys.* **13**, 4683 (1980).
6. S. Okudaira. Multiple ionization of Ca, Sr and Ba by electron impact. *J. Phys. Soc. Jap.* **29**, 409 (1970).
7. J-M. Dettmann, F. Karstensen. Absolute ionization functions for electron impact with barium. *J. Phys. B* **15**, 287 (1982).
8. A. Mäntykenttä, H. Aksela, S. Aksela, A. Yagishita, E. Shigemasa. Configuration interaction and shakeup satellites in 4d, 5s, and 5p photoelectron spectra of Cs and Ba. *J. Phys. B: At. Mol. Opt. Phys.* **25**, 5315 (1992).
9. J. Nienhaus, O.I. Zatsarinny, W. Mehlhorn. Experimental and theoretical Auger and autoionization spectra for electron impact on laser-excited Ba atoms. *Physics Essays* **13**, 307 (2000).
10. G. Snell, M. Martins, E. Kukk, W.T. Cheng, N. Berrah. High-resolution electron spectroscopy of a strongly correlated system: Atomic barium. *Phys. Rev. A* **63**, 062715 (2001).
11. A.A. Borovik. An electron spectrometer for studying the autoionization processes in metal vapors. *Ukr. J. Phys.* **53**, 1021 (2008).
12. E.G. Berezhko, N.M. Kabachnik. Theoretical study of inner-shell alignment of atoms in electron impact ionisation: angular distribution and polarisation of X-rays and Auger electrons. *J. Phys. B: At. Mol. Phys.* **10**, 2467 (1977).
13. O. Borovik. Electron-impact ionization of the $4p^6$ subshell in strontium. *J. Phys. B: At. Mol. Opt. Phys.* **55**, 245202 (2022).
14. V. Hrytsko, G. Kerevičius, A. Kupliauskienė, A. Borovik. The 5p autoionization spectra of Ba atoms excited by electron impact: identification of lines. *J. Phys. B: At. Mol. Opt. Phys.* **49**, 145201 (2016).
15. V. Borovik, V. Hrytsko, I. Shafranyosh, O. Borovik. Electron-impact excitation of the $5p^5 5d6s^2$ autoionizing states in Ba atom. *Ukr. J. Phys.* **65**, 12 (2020).

Received 01.05.24

О.О. Боровик

ДИНАМІКА ЗБУДЖЕННЯ $5p^6$ ОЖЕ СПЕКТРІВ У $Ba + e^-$ ЗІТКНЕННЯХ

Досліджено іонізацію підоболонки $5p^6$ в атомі Ва шляхом вимірювання Оже спектрів, що виникають внаслідок електронного розпаду іонних станів $5p^5 nln'l'$. Виміри проведені в діапазоні енергій електронного удару 23–105 еВ. Отримано енергетичні залежності перерізів іонізації для дев'яти станів в конфігураціях $5p^5 5d^2$, $5p^5 5d6s$ і $5p^5 6s^2$. Аналіз поведінки перерізів дозволив визначити роль прямих і непрямих процесів іонізації підоболонки $5p^6$ в атомі Ва.

Ключові слова: атом, іон, іонізація, автоіонізація, Оже спектри, переріз.