

# LOW STRESS NO DISTORTION WELDING BASED ON THERMAL TENSIONING EFFECTS

QIAO GUAN

Chinese Academy of Engineering,

Beijing Aeronautical Manufacturing Technology Research Institute (BAMTRI). PO Box 863, 100024, Beijing, China.

E-mail: [guanq@cal.cn](mailto:guanq@cal.cn)

In manufacturing sheet metal formed plates, panels and shells by welding, buckling distortions become substantial especially for aerospace structures with material thickness less than 4 mm. To prevent buckling, Low Stress No Distortion (LSND) welding techniques have been pioneered and developed at the Beijing Aeronautical Manufacturing Technology Research Institute. These innovative techniques have been applied successfully in manufacturing aerospace structural components. In this paper, the mechanisms of LSND welding techniques using either the whole cross-sectional thermal tensioning effect or the localized thermal tensioning effect are described and summarized in detail. The basic idea of LSND welding techniques is to perform active in-process control of inherent plastic (incompatible) strains and stresses formation during welding to achieve distortion-free results so that no costly post weld reworking operations for distortion correction is required. Emphasis is given to the finite element analysis to predict and optimize the localized thermal tensioning technique with a trailing spot heat sink coupled to the welding heat source. Selection of parameters for engineering solution are recommended. 21 Ref., 1 Tabl., 15 Fig.

*Keywords: welding residual stress, low stress no distortion welding, buckling distortion, thermal tensioning, temperature gradient stretching, finite element analysis*

**Introduction.** Buckling distortions are more pronounced than any other form of welding distortion in manufacturing thin-walled structures, and they are the main troublesome problem in sheet metal fabrication where fusion welding is applied, especially for aerospace structures such as sheet metal formed airframe panels, fuel tanks, shells of engine cases, etc., where thin sheet materials of less than 4 mm thickness are widely used. Buckling distortions affect the performance of welded structures in a great many ways. During the past decades efforts have been made and progress has been achieved in solving buckling problems by experts in the welding science and technology field world-wide. Many effective methods for removal, mitigation and prevention of buckling distortions adopted before welding, during welding or after welding have been successfully developed and widely applied in industries [1, 2]. Over the past 25 years, authors at the Beijing Aeronautical Manufacturing Technology Research Institute (BAMTRI) have devoted their efforts to achieve distortion-free results in manufacturing thin-walled aerospace structural components by implementing active in-process control of inherent residual plastic strain formation during welding without having to undertake costly reworking operations for distortion correction after welding [3]. Extensive research and development studies to explore Low Stress No Distortion (LSND) welding techniques were carried out at BAMTRI.

Two innovative methods of LSND welding techniques have been developed for industrial application: one is based on the whole cross-section thermal tensioning effect [4], the other is based on the localized thermal tensioning effect [5].

**Buckling Distortions.** The nature of buckling is mostly a phenomenon of loss of stability of thin elements under compressive stresses. Buckling distortions caused by longitudinal welds either in plates, panels or in shells are mainly dominated by longitudinal compressive residual stresses induced in areas away from the weld. Fig. 1, *a, b* show the typical patterns of buckled components. The mechanism of buckling in weldments lies in the action of inherent residual plastic (incompatible) strains formed during welding.

Losing stability, the buckled plate (Fig. 1, *a*) is released from an unstable flat position of high potential energy with the maximum level of residual stress distribution after conventional welding (Fig. 1, *c*) and takes a stable warped shape. Losing stability, the buckled plate reaches a state of minimum potential energy. In other words, any forced change of the stable curvature of the buckled plate will cause increase in potential energy and once the force is removed, the buckled plate will be restored to its stable position minimizing the potential energy.

For plates of thickness less than 4 mm as widely used in aerospace and modern vehicle welded structures, the value of  $\sigma_{cr}$  is much lower than the peak value of compressive stress  $\sigma_{comp\ max}$  after conventional gas tungsten arc welding (GTAW) (Fig. 1, *c*). However, the actual value  $\sigma_{cr}$  for a welded

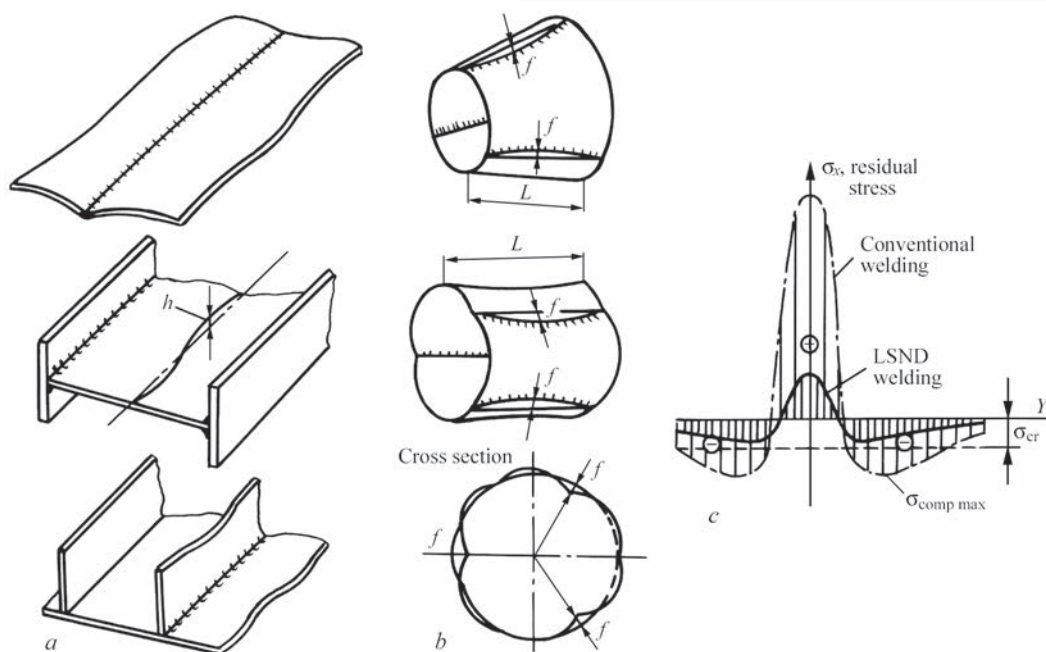

Fig. 1. Typical buckling patterns of plates, panels (a) and shells (b) with longitudinal welds; to prevent buckling, reduce  $\sigma_{comp\ max}$  to a value lower than  $\sigma_{cr}$  (c), thus achieving the low stress no distortion result

element is difficult to be solely determined either by the linear stability theory of small deformations or by the non-linear theory of large deformations in theory of plates and shells. These problems are very complex [6].

In principle, all efforts either 'passive' post-weld correction measures or 'active' in-process control methods of LSND welding to eliminating buckling aim at adjusting the compressive residual stresses to achieve  $\sigma_{comp\ max} < \sigma_{cr}$  at which buckling occurs (Fig. 1, c) by means of reduction and redistribution of the inherent residual plastic strains.

In the past decade, welding simulation and prediction by computational method has been increasingly applied in addition to classic analytical and conventional empirical procedures. Finite element method was adopted by Michaleris, Deo et al [7, 8] for analyzing buckling distortions of stiffened rectangular welded plates for shipbuilding. Shrinkage forces were obtained from a thermal elastic-plastic cross-sectional model analysis. Based on the finite element analysis for large displacements, and using an inherent shrinkage strain method, Tsai et al [9] investigate the buckling phenomena of a rectangular plate of aluminum alloy with longitudinal T stiffeners.

Buckling can be controlled by a variety of methods applied before welding, during welding, and after welding for its removal, mitigation or prevention.

Pre-tensioning can be classified in either the category of methods applied before or during welding [10]. For each particular structural design of panels, a device for mechanical tensile loading is required.

Owing to their complexity and low efficiency in practical execution, application of these methods is limited. In this respect, the thermal tensioning technique is more flexible in stiffened panel fabrication.

LSND results could be achieved during the welding process based on the thermal tensioning ( temperature gradient stretching ) effect which is produced by establishing a specific temperature gradient either in whole cross section of the plate to be welded or in a localized area in the near-arc zone. Simultaneously, restraining transient out-of-plane warpage movements of the workpiece is necessary. Differing from the 'passive' methods which have to be applied after welding once buckling is in existence, LSND welding techniques can be classified as 'active' methods for in-process control of buckling distortions with no need of reworking operations after welding.

**Thermal Tensioning Effects.** The method for low temperature stress relieving [11] is well-known in shipbuilding and vessel manufacturing industries. This technique is practiced with flame heating combined with water cooling of thicker plate sections of thickness 20...40 mm for mitigation of longitudinal residual stresses after welding. It is based on temperature gradient stretching effect induced by local linear heating and cooling parallel to the weld-line on plates. This technique is not applicable for either stress relieving or buckling removal after welding of thin-walled elements of less than 4 mm thickness where the metal sheets are not stiff enough to resist the transient out-of-plane displacement during local heating and forced cooling. But the

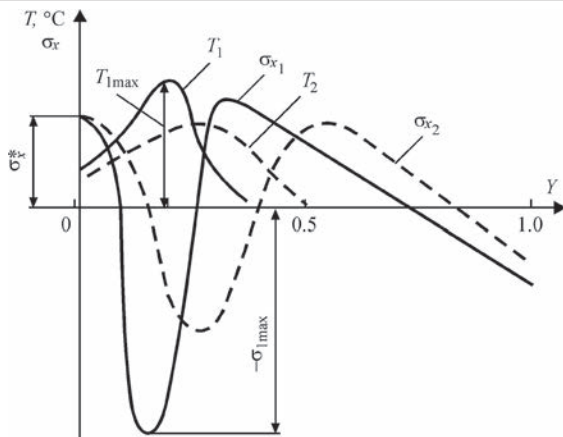

Fig. 2. Basic principle of whole cross-section thermal tensoning effect

idea of the temperature gradient stretching effect (or commonly termed thermal tensoning effect) is logically feasible for avoiding buckling of plates and shells during welding. Efforts in this direction were made during last decades [2–4, 12–14].

The basic principle of the whole cross-section thermal tensoning effect is shown in Fig. 2. Two curves ( $\sigma_{x1}$  and  $\sigma_{x2}$ ) of thermal stress distributions are created by a preset heating with the temperature profiles ( $T_1$  and  $T_2$ ) correspondingly on the thin plate. In this case, the thermal tensoning effect is defined as the value of  $\sigma_x^*$  in the plate edge of  $Y=0$  where the weld bead will be applied. For a given  $\sigma_x^*$ , the greater temperature gradient ( $\partial T_1 / \partial Y > \partial T_2 / \partial Y$ ), the higher will be the induced maximum value of compressive stress  $-\sigma_{1x,max}$ . An optimized temperature curve can be calculated mathematically for an estimated value  $\sigma_x^*$  while the value  $-\sigma_{1x,max}$  is kept below the yield stress.

Based on the results of mathematical analysis for the thermal tensoning effect, Burak et al [13,

14] conducted an experiment to control longitudinal plastic strains in weld on aluminum plate of 4 mm thickness.

Early in the 1980's, to apply the thermal tensoning effect to avoid buckling in aerospace structures of less than 4 mm thickness, a series of experiment was carried out by Guan et al [4, 12]. It has been proved by the results of repeated experiments that the Burak's scheme for the plates thicker than 4 mm is not applicable to eliminating buckling in elements of less than 4 mm thickness. The reason is that owing to the susceptibility to losing stability of the thinner elements, transient out-of-plane displacements occur in areas away from the weld zone (Fig. 3, a). The transient out-of-plane displacements outside the clamping fingers (indicated by  $P$  in Fig. 3, a) release the potential energy of the thermal plane stresses distribution. In the lost stability position, the expected preset thermal tensoning stress  $\sigma_x^*$  (Fig. 2) ceases to exist.

Progress was made in solving the above mentioned problem to improve the thermal tensoning technique and make it applicable to elements of less than 4 mm thickness especially in manufacturing aerospace structures [4]. Fig. 3, b shows the improvement in clamping systems. In conventional clamping system with 'one-point' finger fixture (indicated by  $P_1$  in Fig. 3, a), the transient out-of-plane warpages of the workpiece are inevitable, whereas, using the improved 'two-point' finger clamping system (indicated by  $P_1$  and  $P_2$  in Fig. 3, b) the desirable thermal tensoning effect in terms of  $\sigma_x^*$  (Fig. 2) can be established without transient out-of-plane warpage displacements.

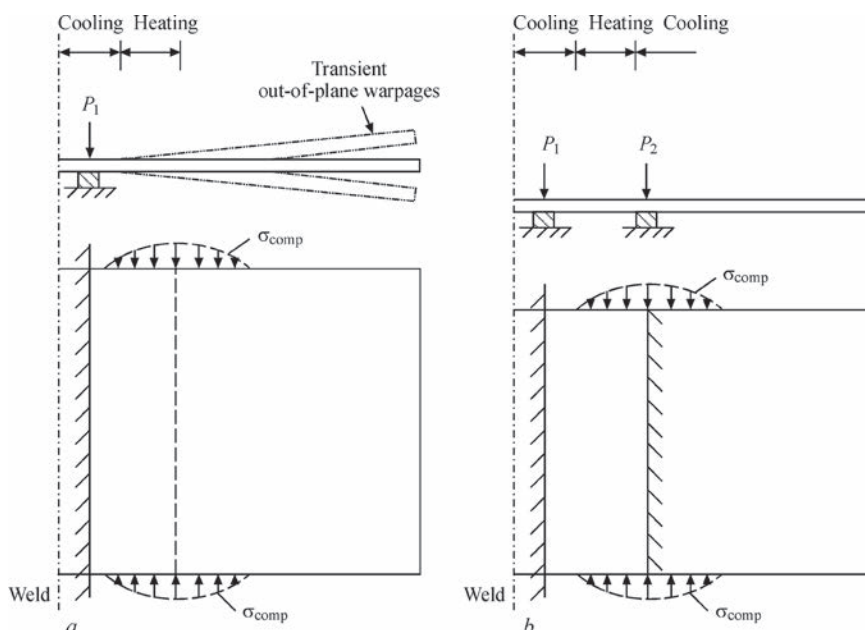
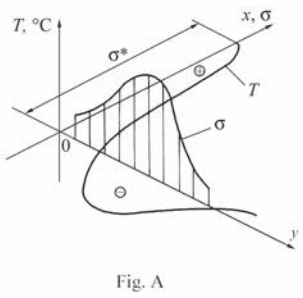
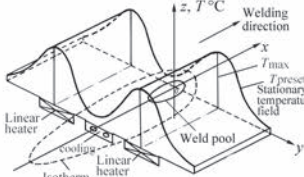
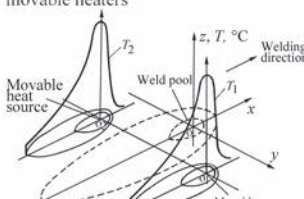
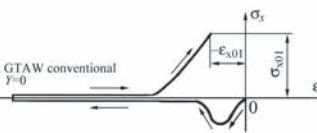
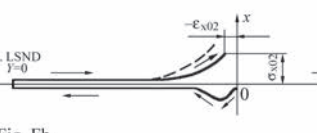
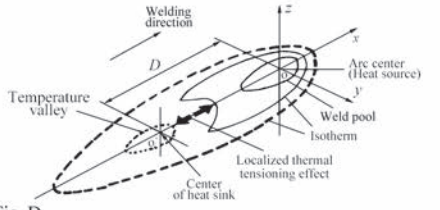
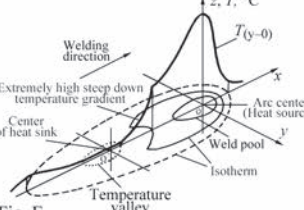
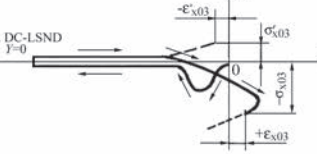

Fig. 3. Transient out-of-plane warpage displacement of workpiece in conventional clamping system (a) and its prevention in the newly improved 'two-point' fingers clamping system (b) [4]

Two categories of thermal tensoning effects

Two categories of thermal tensoning effects	Basic principles –Action of thermal tensoning effect (temperature gradient stretching)	Setup of temperatura profile	Comparison of thermo-stress–strain histories at the weld center line $Y = 0$
Entire cross-sectional thermal tensoning created by additional heating and cooling to implement LSND welding	<p>To implement Low Stress No Distortion welding the thermal tensoning effect defined as <math>\sigma^*</math> is induced at the plate edge to be welded by the temperature profile <math>T</math> (necessary condition)</p>  <p>Fig. A</p> <p>The sufficient condition to achieve LSND welding result is preventing out-of-plane displacements by applying flattening forces</p>	<p>Preset temperature profile set up by stationary linear heaters and cooling</p>  <p>Fig. B</p> <p>Transient temperature profile set up by movable heaters</p>  <p>Fig. C</p>	<p>a) For conventional GTAW at <math>Y=0</math>, the residual stress <math>\sigma_{x01}</math> and strain <math>-\epsilon_{x01}</math> approach <math>\sigma_s</math> &amp; <math>\epsilon_s</math></p>  <p>Fig. Fa</p> <p>b) In case of LSND welding at <math>Y=0</math>, the residual stress <math>\sigma_{x02}</math> and strain <math>-\epsilon_{x02}</math> can be much lower than <math>\sigma_s</math> &amp; <math>\epsilon_s</math></p>  <p>Fig. Fb</p>
Localized thermal tensoning created by use of trailing spot heat sink without additional heating	<p>To execute DC-LSND welding localized thermal tensoning is induced within a certain welding isotherm</p>  <p>Fig. D</p>	<p>Extremely high-temperature gradient is induced between heat source and heat sink</p>  <p>Fig. E</p>	<p>c) For DC-LSND welding at <math>Y=0</math>, the sign of residual stress <math>\sigma_{x03}</math> and strain <math>\epsilon_{x03}</math> are alterable depending on the steepness of the temperature gradient</p>  <p>Fig. Fc</p>

As an active in-process control method, this improved technique is more widely acknowledged as LSND welding method for thin materials [3, 4]. It is worthwhile to note, that the LSND welding technique as an active in-process control method is replacing the formerly adopted passive measures for buckling removal after welding in most cases in aerospace engineering in China.

To create the whole cross-section thermal tensoning effect along the plate edges to be welded, the temperature profile can be built up either statically as a preset temperature field by stationary linear heaters arranged underneath the workpiece parallel to the weld direction or as a transient temperature field built up by two movable heating devices on both sides of the weld and synchronously traveling with the welding torch [15]. The LSND welding techniques can be implemented in either of the two ways.

In a broad sense of the term ‘thermal tensoning’, the effect can be created not only in the longitudinal direction of the weld to control the longitudinal plastic strains in weld zone, but the effect in mitigating the transverse shrinkage of the weld could also be utilized for hot-cracking prevention [16]. Furthermore, manipulating the combination of heat sources and heat sinks, the thermal tensoning effect as well as the thermal compressing effect could also be established properly for specific purposes. Mitigating residual stresses

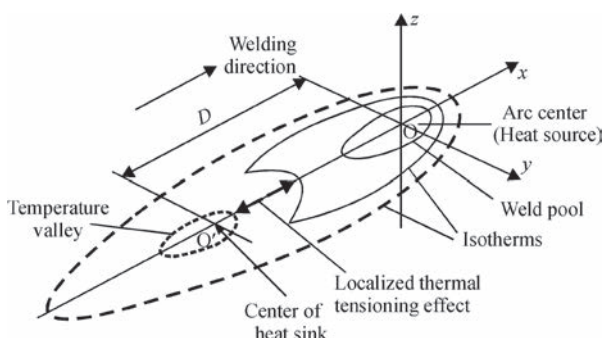

Fig. 4. Localized thermal tensoning effect (shown by heavy arrows) induced by a trailing spot heat sink coupled to the welding arc in a distance  $D$  behind

in Al-Li repair welds [17] is an example in applying the alternative options of thermal tensoning effect.

The thermal tensoning effects can be classified into two categories: one is created in an entire cross-section of plate ( whole cross-section thermal tensoning ) using additional heating and cooling as mentioned above, the other is created in a localized zone limited to a near arc high temperature area within a certain isotherm induced solely by welding arc without any additional heating ( localized thermal tensoning ), as classified in the table.

For the localized thermal tensoning a source-sink system — a heat sink coupled with welding heat source, could be utilized (Fig. 4).

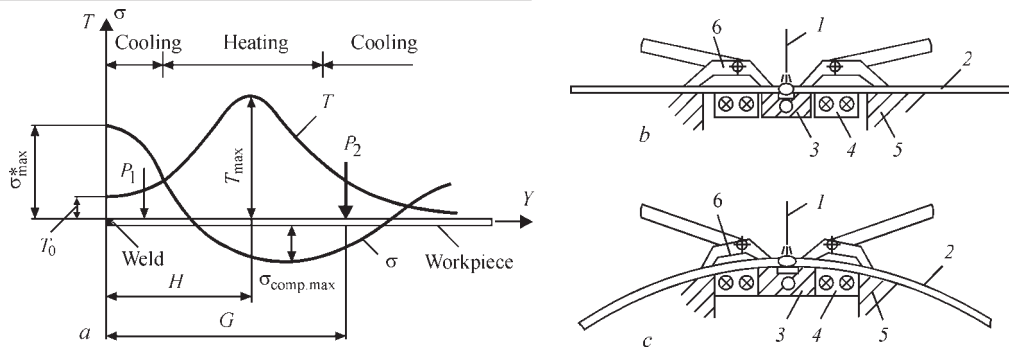

Fig. 5. Basic principle for implementation of LSND welding (a), clamping jigs for longitudinal weld in plates (b) and cylindrical shells (c) [4]: 1 — arc; 2 — workpiece; 3 — water-cooling backing bar; 4 — linear heaters; 5 — supporting mandrel; 6 — 'two-point' finger clamping system

**Whole Cross-Sectional Thermal Tensioning — LSND Welding.** To satisfy the stringent geometrical integrity requirements and ensure dimensionally consistent fabrication of aerospace structures, LSND welding technique for thin materials, mainly for metal sheets of less than 4 mm thickness, was pioneered and developed early in 1980's at the Beijing Aeronautical Manufacturing Technology Research Institute [4, 12]. This technique was aimed to provide an in-process active control method to avoid buckling distortions based on the whole cross-section thermal tensioning effect.

Fig. 5. shows schematically the basic principle for practical implementation of LSND welding [4]. The thermal tensioning effect with the maximum tensile stress  $\sigma_{max}^*$  in the weld zone (Fig. 5, a) is formed due to the cooling contraction of the zone 1 by water-cooling backing bar underneath the weld and the heating expansion of zone 2 on both sides adjacent to the weld by linear heaters. Both the curve  $T$  and curve  $\sigma$  are symmetrical to the weld centerline. The higher

$\sigma_{max}^*$ , the better will be the results of controlling buckling distortions.

It is proved by experiments and engineering applications, that the thermal tensioning effect is the necessary condition for LSND welding of materials of less than 4 mm thickness, whereas the sufficient condition is the prevention of transient out-of-plane displacements by applying flattening forces in 'two-point' finger clamping systems shown by  $P_1$  and  $P_2$  in Fig. 5, a. The selected curve  $T$  is mainly determined by:  $T_{max}$ ,  $T_0$  and  $H$  — distance of  $T_{max}$  to the weld centerline. The thermal tensioning effect  $\sigma_{max}^*$  becomes stronger as the temperature gradient ( $T_{max} - T_0$ ) increases while  $H$  decreases. The optimization of  $\sigma_{max}^*$  and technological parameters such as  $H$  etc. can be implemented computationally using FEA and verified experimentally. Fig. 5 shows schematic views of practical implementation of LSND welding method and apparatus for longitudinal joints in flat plates (Fig. 5, b) and cylindrical shells (Fig. 5, c).

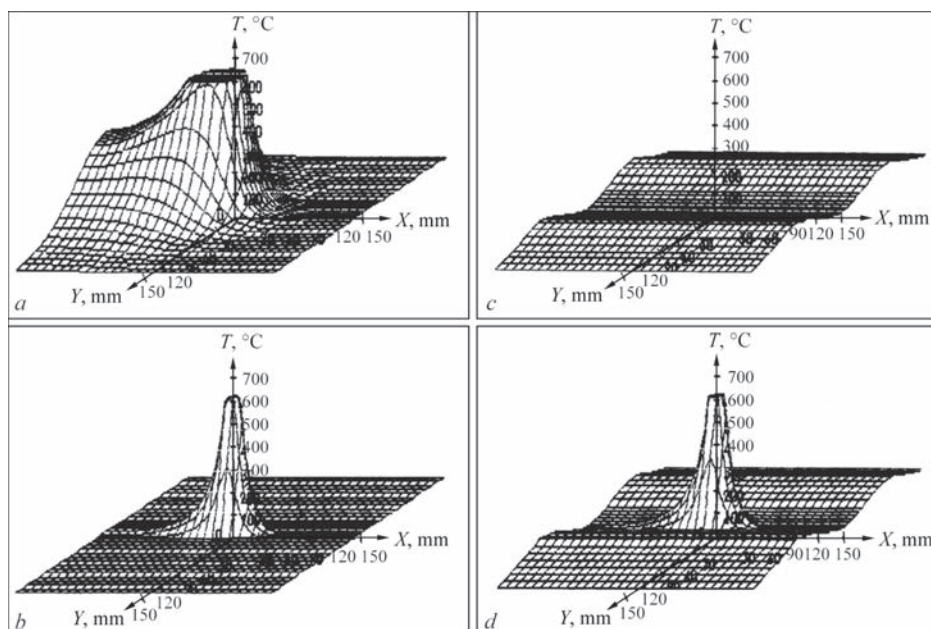

Fig. 6. Temperature fields on thin plate of conventional GTAW (a), GTAW on copper backing bar with intensive heat transfer (b), preset temperature field (c) and temperature field for LSND welding (d)

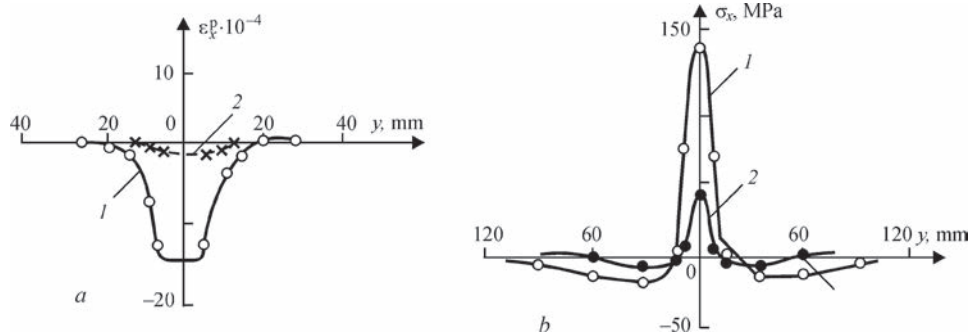

Fig. 7. Comparisons between experimentally measured inherent strains  $\varepsilon_x^p$  (a) and residual stresses  $\sigma_x$  (b) distributions after conventional GTAW (curve 1) and LSND welding (curve 2) of aluminum plate of 1.5 mm thick [3, 12]

The typical temperature field in GTA welding of thin plate is shown schematically in Fig. 6, a. Actually, in engineering practice, the GTAW of longitudinal weld on thin plate is performed in a longitudinal seam welder. Workpieces are rigidly fixed in a pneumatic finger-clamping system with copper backing bar on mandrel support. Owing to the intensive heat transfer from workpiece to copper backing bar, the temperature field is different from the normal shape and takes a narrowed distribution as shown in Fig. 6, b. To implement LSND welding, additional preset temperature field as shown in Fig. 6, c is formed by heating and cooling. Therefore, the LSND welding temperature field shown in Fig. 6, d results by superposition of the temperature fields of Fig. 6, b, c.

For clearer quantitative assessment of LSND welding technique, a systematic investigation was carried out [3, 12]. Fig. 7 shows comparisons between the experimentally measured inherent strain  $\varepsilon_x^p$  distributions (Fig. 7, a) and residual stress  $\sigma_x$  distributions (Fig. 7, b) after conventional GTAW (curve 1) and LSND welding (curve 2) of aluminum plate of 1.5 mm thick. Reductions of either  $\varepsilon_x^p$  or  $\sigma_x$

are obvious (as indicated by curve 2 in comparison with curve 1).

The photographs in Fig. 8 show that the specimens of either stainless steel (Fig. 8, a) or aluminum alloy (Fig. 8, b) welded conventionally (upper photo) are severely buckled in all cases. But the specimens welded by use of LSND welding (lower photo) are completely buckle-free and as flat as before welding.

Comparisons are also given in Fig. 8, c, d between the results of measured deflections  $f$  on specimens of 1.6 mm thick welded conventionally using GTAW and those welded using LSND welding technique for stainless steel (Fig. 8, c) and aluminum alloy (Fig. 8, d). Completely buckle-free ( $f = 0$ ) results were achieved while the optimized technological parameters for LSND welding techniques were selected.

As demonstrated above, designers and manufacturers who suffer from problems of buckling could now adopt a new idea that buckling is no longer inevitable with LSND welding technique. Buckling can be prevented completely and residual stresses can be reduced significantly or controlled to a level lower than  $\sigma_{cr}$  at which buckling occurs.

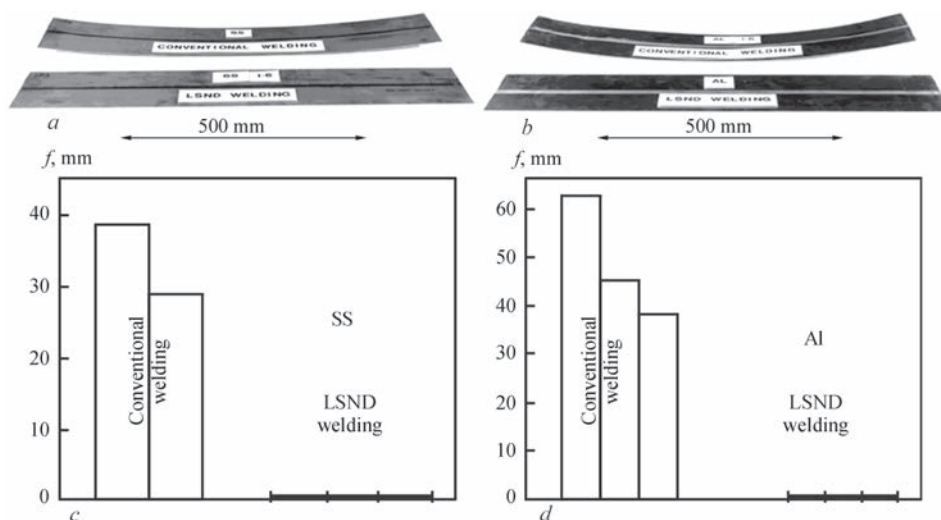

Fig. 8. Specimens of 1.6 mm thick, 1000 mm long, of stainless steel (a) and aluminum alloy (b) welded by conventional GTAW, severely buckled (upper), and welded by LSND welding, buckle-free (lower). Completely buckle-free results ( $f = 0$ ) can be achieved using optimized LSND welding technique on both stainless steel (c) and aluminum alloy (d) specimens of 1.6 mm thick

Successful results in preventing buckling distortions were achieved in manufacturing thin-walled jet engine cases of nickel base alloys, stainless steels as well as rocket fuel tanks of aluminum alloys where the acceptable allowance of residual buckling deflections  $f$  at a weld length of  $L$  should be limited to the ratio of  $f/L < 0.001$  [18].

**Localized Thermal Tensioning — LSND Welding with a Trailing Spot Heat Sink.** Over the past 10 years, progress has been made in seeking active in-process control of welding buckling to exploit a localized thermal tensioning technique using a trailing spot heat sink. The heat sink moving synchronously with the welding arc creates an extremely high temperature gradient along the weld bead within a limited area of high temperature zone close to the weld pool (Fig. 4). This technique was entitled «Dynamically Controlled Low Stress No Distortion welding method» (DC-LSND) [5, 18, 19]. In this innovative method, the preset heating (as shown in Fig. 5, *a*) is no longer necessary. The formation of specific inverse plastically stretched inherent strains  $\varepsilon_x^p$  in the near arc zone behind the welding pool is dynamically controlled by a localized trailing thermal tensioning effect induced between the welding heat source and the spot heat sink along the weld bead (Fig. 4).

Device for engineering implementation of the DC-LSND welding technique was designed and further developed at BAMTRI as shown schematically in Fig. 9 [5].

With this device attached to the welding torch, an atomized cooling jet of the trailing spot heat sink impinges directly on the just solidified weld bead. Liquid coolant, such as  $\text{CO}_2$ , Ar,  $\text{N}_2$  or water, could be selected for atomized cooling jet. Atomizing the liquid coolant is essential to improve the efficiency of intensive cooling rather than using liquid jet directly impinging the weld bead. To protect the arc from the possible interference of the cooling media, there is a co-axial tube to draw the vaporized media

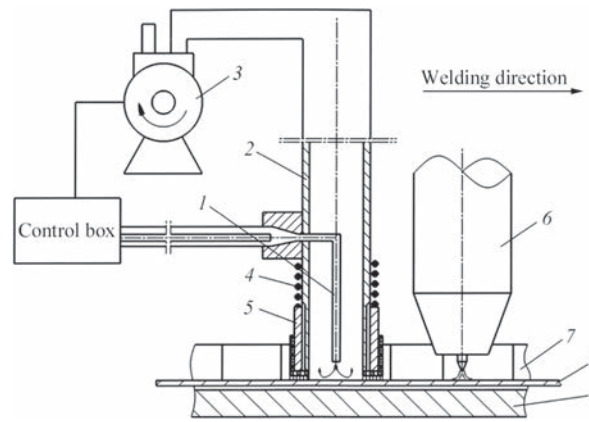

Fig. 9. Specially designed device for buckle-free DC-LSND welding of thin-walled elements [5]: 1 — nozzle for atomized cooling jet of liquid media; 2 — co-axial tube to draw the vaporized coolant; 3 — vacuum pump; 4 — spring; 5 — axle over-sleeve tube; 6 — GTA welding torch; 7 — clamping fingers; 8 — workpiece; 9 — beneath weld backing bar

out of the zone nearby the arc. The technological parameters for the trailing spot heat sink and all the welding procedures are automatically synchronously-controlled with the GTAW process. The dominating factors: the distance between the heat source and the heat sink, the intensity of the cooling jet can be selected properly to reach a buckle-free result.

In systematic investigations, finite element analysis with a model of cooling jet impinging the weld bead surface is combined with a series of experimental studies [19–21]. Comparisons between the temperature fields on conventional GTA welded titanium plate and on plate welded using DC-LSND technique are given in Fig. 10.

In this case, DC-LSND welding was carried out using the same parameters as in conventional GTA welding. The flow rate of cooling medium (atomized water) was selected at 2.5 ml/s. The distance between the arc and cooling jet were regulated from 80 mm to 25 mm. It can be seen clearly (Fig. 10, *b, d*) that in DC-LSND welding there is a deep temperature valley formed by the cooling jet behind the weld pool. An extremely high temperature gradient from the peak to

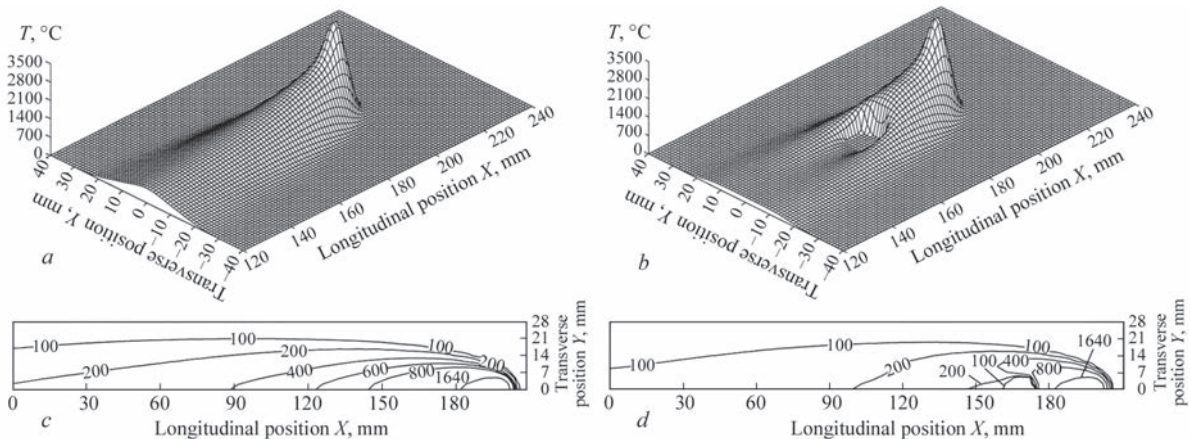

Fig. 10. Temperature fields and isotherms on Ti-6Al-4V (2.5 mm thick) plate [20], welding parameters: 200 A, 12 V, 12 m/h; *a, c* — conventional GTA welding on copper backing bar; *b, d* — DC-LSND welding

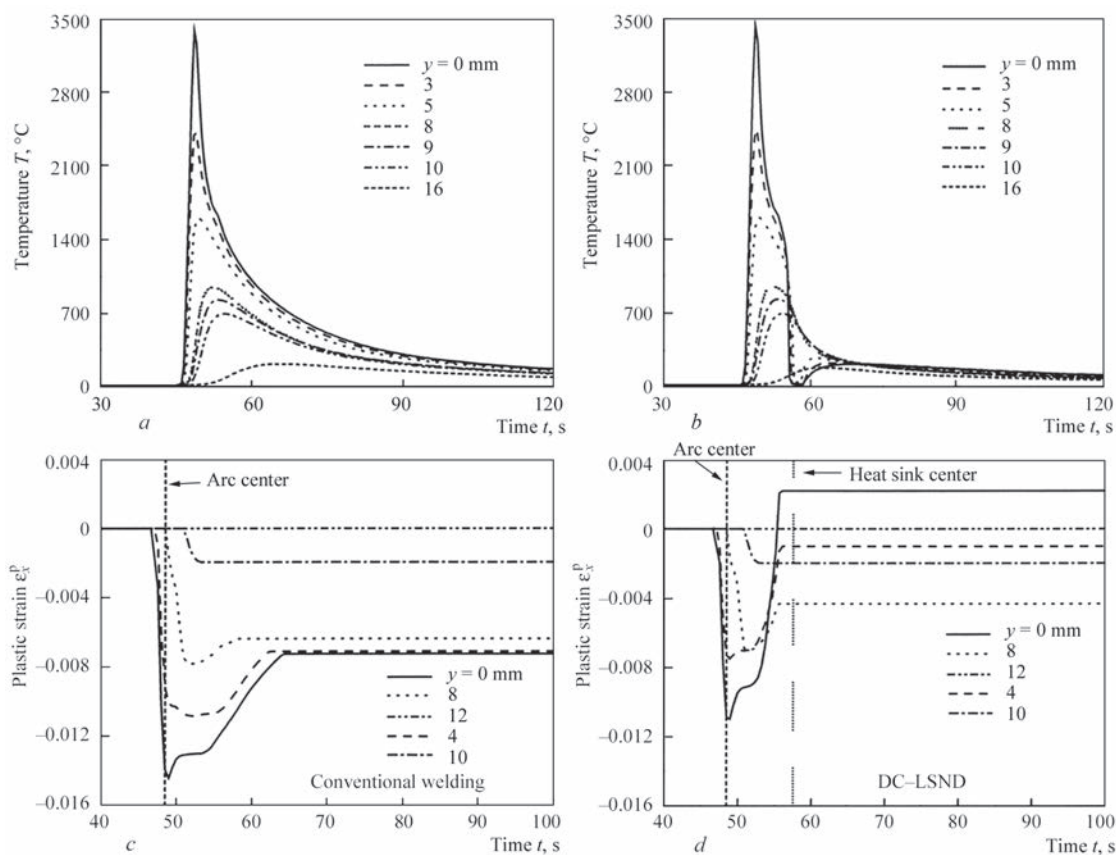

Fig. 11. Comparisons of thermal cycles (*a, b*) and transient plastic strain cycles (*c, d*) between conventional GTAW (*a, c*) and DC-LSND welding (*b, d*) [20]

the valley is created. The 800 °C and 400 °C isotherms in front of the heat sink are severely distorted pushing forward closer to the weld pool (Fig. 10, *d*).

The abnormal thermal cycles by DC-LSND welding (Fig. 11, *b*) produce correspondingly the abnormal thermo-elastic-plastic stress and strain cycles (Fig. 11, *d*) in comparison with the cycles formed by conventional GTAW (Fig. 11, *a, c*). Obviously, the localized thermal

tensioning effect is acting only within a limited zone behind the weld pool.

It can be seen also from Fig. 11, *d*, that behind the arc, the compressive plastic strains formed before in the just solidified weld zone can be compensated properly by the inherent tensile plastic strains in the area of temperature valley (Fig. 11, *d*).

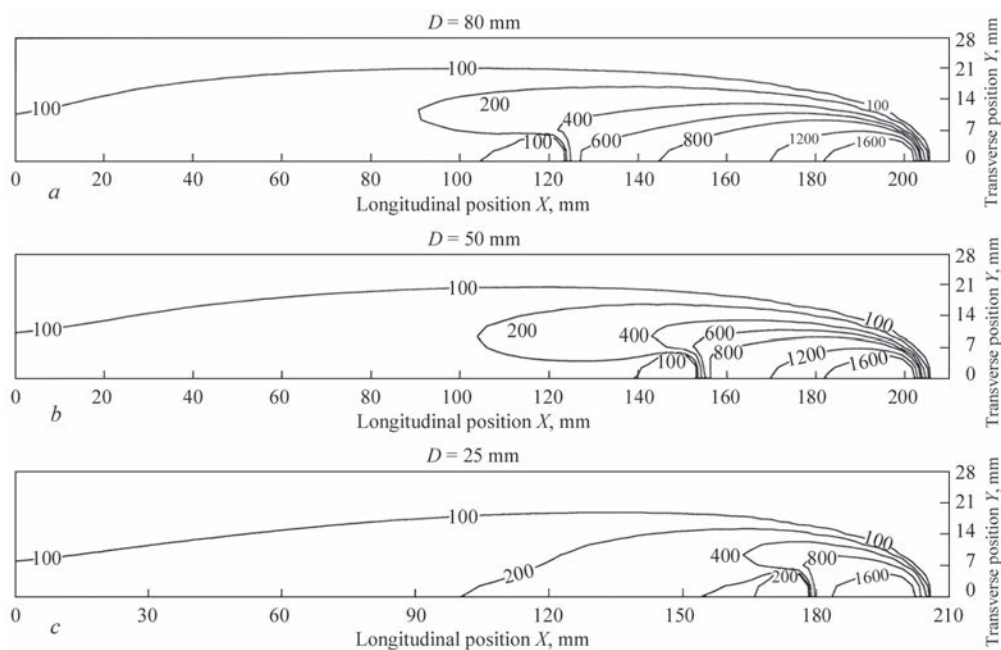

Fig. 12. Isotherms on titanium plate with different distance  $D$  between the arc center and the cooling jet center [20]



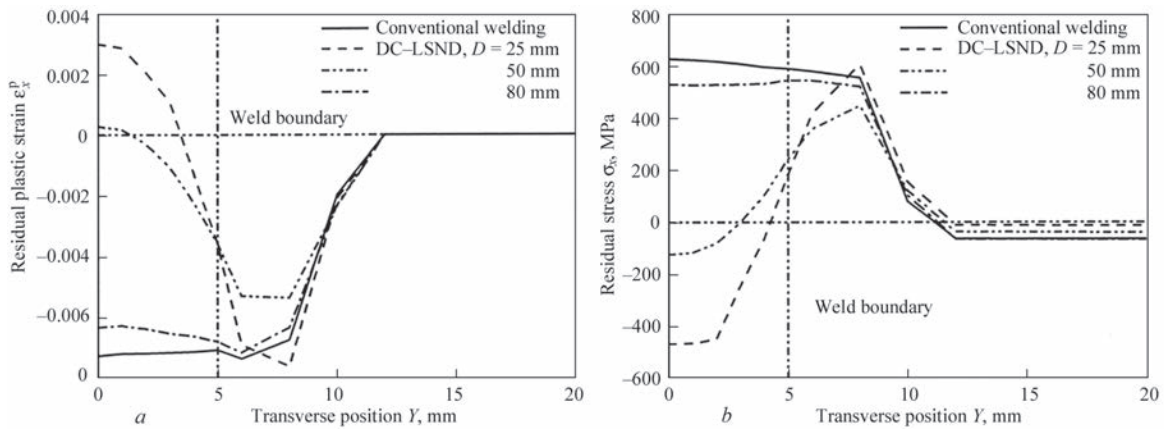

Fig. 13. Residual strain  $\varepsilon_x^p$  (a) and stress  $\sigma_x$  (b) distributions in cross-section of the weld on titanium plate welded conventionally and using DC-LSND welding technique [21]

In DC-LSND welding, both the value of inherent plastic strains and the width of its distribution can be controlled quantitatively by selecting the proper technological parameters: the distance  $D$  between the welding heat source and the heat sink (Fig. 12) as well as the intensity of the heat sink.

Fig. 13 shows the residual strain (a) and stress (b) distributions in cross-section of the weld on titanium plate. Comparisons are given between conventional welding (shown by solid line) and DC-LSND welding with different distance  $D = 25$  mm, 50 mm, 80 mm (Fig. 12). For a selected intensity of heat sink, the closer the heat sink to the heat source (the shorter the distance  $D$ ), the stronger is the localized thermal tensioning effect. For example, at the distance  $D = 25$ , the residual plastic inherent strain  $\varepsilon_x^p$  on the weld centerline even changes its sign from negative to positive (Fig. 13, a), and the residual stress on the weld centerline changes from tensile to compressive correspondingly (Fig. 13, b).

Fig. 14 gives some typical examples from the systematic investigation program. As shown in Fig. 14, a, the peak tensile stress in weld on mild steel plate welded using conventional GTAW reaches 300 MPa (curve 1) and the maximum compressive stress in the peripheral area is about 90 MPa which causes buckling with deflections more than 20 mm in the center of specimen of 500 mm long. In the case of DC-LSND welding the patterns of residual stress distribution (curves 2, 3, 4) alter dramatically with different technological parameters, even with the compressive residual stresses in the centerline of the weld. The reason is that the shrinkage induced by the great temperature gradient between the arc and the cooling jet tends not only to compensate the welding compressive plastic strains but also to alter the sign of residual strain to its opposite. Results show that the distance  $D$  has more significant influence on both  $\varepsilon_x^p$  and  $\sigma_x$  in controlling buckling on thin materials. After DC-LSND welding, the specimens are completely buckle-free and as flat as original before welding.

Similar results were obtained as shown in Fig. 14, b, c on stainless steel and aluminum plates. Based on the experimental investigations and FEA results, the recommended parameters for engineering application of DC-LSND welding are given in Fig. 15 (for the

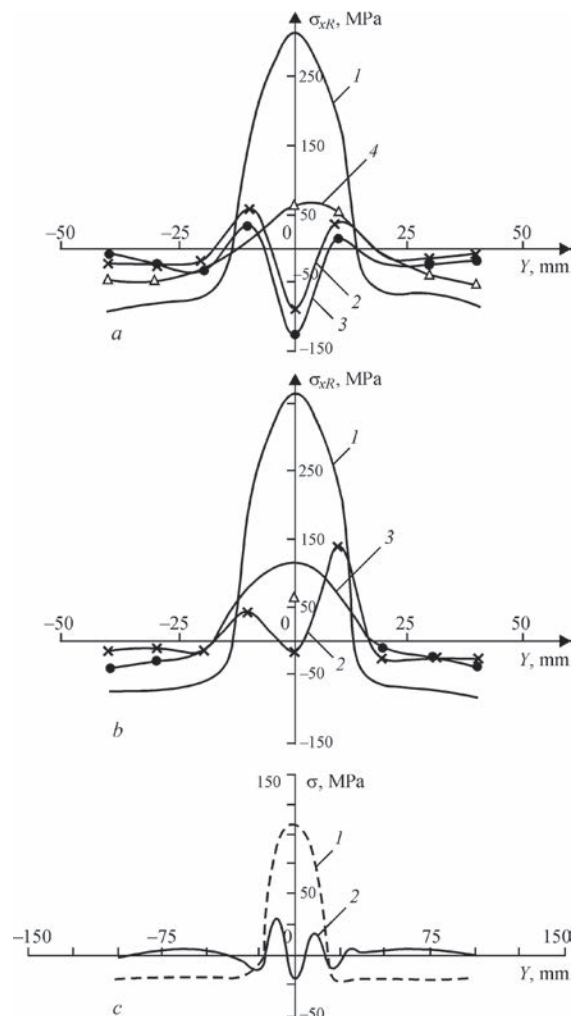

Fig. 14. Measured residual stress distributions on plates 1 mm thick mild steel (a), stainless steel (b) and 2 mm thick aluminum alloy (c) welded using conventional GTAW (curve 1) and by use of DC-LSND welding technique (2 —  $D = 25$  mm, 3 — 50 mm, 4 — 80 mm) [19]

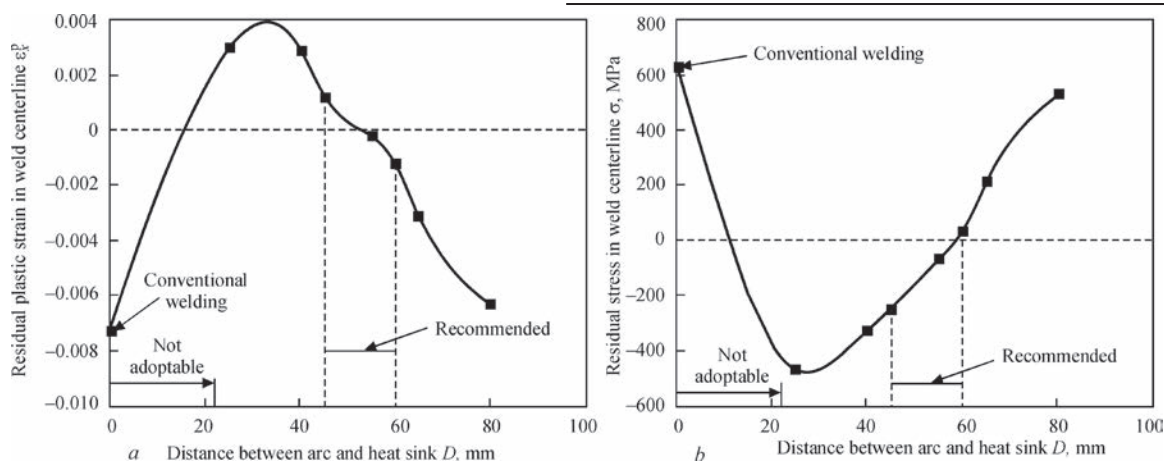

Fig. 15. The peak value of residual plastic strain  $\epsilon_x^p$  in weld centerline (a) and residual stress  $\sigma_x$  in weld centerline (b) as function of distance  $D$  (according to Fig. 13)

case of titanium plate examined according to Fig. 10) to achieve buckle-free results.

Metallurgical and mechanical examinations show that the cooling jet medium gives no noticeable influence on the titanium weld joint properties. Actually the cooling jet is impinging directly on the solidified weld bead at a temperature less than 400 °C as shown by the distorted abnormal isotherm of 400 °C in front of the heat sink.

Recent progress in numerical simulation of welding phenomena offers researchers powerful tools for studying in more detail of welding thermal and mechanical behaviors. These tools allow for the prediction of precise control of the abnormal temperature fields and therefore the abnormal thermal elastic-plastic cycles created by the possible variable combinations of the heat source-heat sink welding techniques. It is expected that a variety of coupled heat source-heat sink processes are feasible for not only welding distortion controlling but also defect-free welds. For example, the device for trailing spot heat sink can be attached not only to the GTAW torch but also could be coupled to other heat sources like laser beam or friction stir welding tool to control distortion, and to improve joint performances as well.

### Conclusions

1. LSND welding techniques for thin materials can be implemented using either the whole cross-sectional thermal tensioning effect or the localized thermal tensioning effect.

2. Basic principles and mechanism of LSND welding techniques are clarified through experimental studies and theoretical analyses with FEA.

3. For LSND welding using the whole cross-sectional thermal tensioning, the necessary condition is to create an adequate temperature profile coupled to the welding temperature field whereas its sufficient condition is to keep the thin plate elements in a plane position without any transient loss of stability during welding.

4. In executing DC-LSND welding technique using localized thermal tensioning, the dominating technological parameters are: the distance between the heat source and the heat sink and the intensity of the heat sink. For engineering solution and industrial application, optimized technological parameters are recommended based on FEA results.

5. Both LSND welding techniques have been applied successfully in sheet metal industries to satisfy the stringent geometrical integrity requirements especially to ensure dimensional consistent fabrication of aerospace components.

### Acknowledgments

This paper summarizes the main results of a series of research projects supported by the National Natural Science Foundation of China under Contract No. IX-85343 and the Foundation for Aerospace Science and Technology of China under Contracts No. 87625003, No. 98H25002. The author would like to express his gratitude to BAMTRI for the constant support to develop the LSND welding techniques and promote their industrial applications.

### References

1. Terai, K. (1978) Study on prevention of welding deformation in thin-skin plate structures. *Kawasaki Technical Review*. (61): 61-66.
2. Masubuchi, K. (1980) *Analysis of welded structures*. Oxford, Pergamon Press.
3. Guan, Q. (1999) A survey of development in welding stress and distortion control in aerospace manufacturing engineering in China, *Welding in the World*, 43(1): 14-24.
4. Guan, Q., Guo, D. L. et al. (1987) *Method and apparatus for low stress no-distortion welding of thin-walled structural elements*. Original Chinese patent 87100959.5. 1988. International patent specification No PCT/GB88/00136.
5. Guan, Q., Zhang, C. X. et al. (1993) *Dynamically controlled low stress no-distortion welding method and its facility*. Chinese patent 93101690.8.
6. Zhong, X. M., Murakawa, H. and Ueda, Y. (1995) Buckling behavior of plates under idealized inherent strain. *Transactions of JWRI*. 24(2): 87-91.
7. Michaleris, P. et al. (1999) Minimization of welding residual stress and distortion in large structures. *Welding Journal*. 78(11): 361-s to 366-s.

8. Deo, M. V., Michaleris, P. (2003) Mitigating of welding induced buckling distortion using transient thermal tensioning. *Science and Technology of Welding and Joining*. 8(1): 49-54.
9. Tsai, C. L. et al. (1999) Welding distortion of a thin-plate panel structure. *Welding Journal*. 78(5): 156-s to 165-s.
10. Paton, B. E. et al. (1989) Fabrication of thin-walled welded large panels of high strength aluminum alloys. *Avt. Svarka*. (10) (in Russian).
11. Radaj, D. (1992) *Heat effects of welding: temperature field, residual stress, distortion*. Berlin, Springer-Verlag.
12. Guan, Q. et al. (1990) Low stress no-distortion (LSND) welding — a new technique for thin materials. *Transactions of Chinese Welding Society*. 11(4): 231-237 (in Chinese).
13. Burak, Ya. I. et al. (1977) Controlling the longitudinal plastic shrinkage of metal during welding. *Avt. Svarka* (3): 27-29.
14. Burak, Ya. I. et al. (1979) Selection of the optimum for preheating plates before welding. *Avt. Svarka* (5): 5-9.
15. Mechaleris, P. et al. (1995) Analysis and optimization of weakly coupled thermo-elasto-plastic systems with application to weldment design, *Int. J. for Numerical Methods in Engineering*. 38:1259-1285.
16. Yang, Y. P., Dong, P., Zhang, J. and Tian, X. T. (2000) A hot-cracking mitigation technique for welding high-strength aluminum alloy. *Welding Journal*. 79(1): 9-s to 17-s.
17. Dong, P. et al. (1998) Analysis of residual stresses in Al-Li repair welds and mitigation techniques. *Welding Journal*. 77(11): 439-s to 445-s.
18. Guan, Q. et al. (1996) Low stress no-distortion welding for aerospace shell structures. *China Welding*. 5(1): 1-9.
19. Guan, Q., Zhang, C. X. et al. (1994) Dynamic control of welding distortion by moving spot heat sink. *Welding in the World*, 33(4): 308-313.
20. Li, J., Guan, Q., Shi, Y. W. et al. (2004) Studies on characteristics of temperature field during GTAW with a trailing heat sink for titanium sheet. *Journal of Materials Processing Technology*. 147(3): 328-335.
21. Li, J., Guan, Q., Shi, Y. W. and Guo, D. L. (2004) Stress and Distortion mitigation technique for welding titanium alloy thin sheet. *Science and Technology of Welding and Joining*, 9, 5, 451-458.

## ЗНИЖЕННЯ РІВНЯ БЕЗДЕФОРМАЦІЙНИХ ЗВАРЮВАЛЬНИХ НАПРУЖЕНЬ ТЕРМІЧНИМ НАТЯГОМ

ГУАН ЦЯО

Китайська інженерна академія, Пекінський науково-дослідний інститут технології виробництва авіатехніки (BAMTRI).  
a/c 863, 100024, Пекін, Китай. E-mail: guanq@cal.cn

При виготовленні листових пластин, панелей і оболонок за допомогою зварювання деформації поздовжнього вигину стають істотними, особливо для аерокосмічних конструкцій з товщиною металу менше 4 мм. Для запобігання втрати стійкості розроблено методи зварювання з низькою напругою без деформацій. Ці інноваційні методи успішно застосовуються у виробництві аерокосмічних конструкційних компонентів. У статті докладно описано та узагальнено особливості методів зварювання з низькою напругою без деформацій з використанням або повного ефекту термічного натягу поперечного перерізу, або ефекту локального теплового натягу. Основна ідея цих методів зварювання полягає в тому, щоб виконувати активне управління процесом характерних пластичних (несумісних) деформацій та напружень при зварюванні для отримання результатів без деформацій, щоб не було потрібно дорогих операцій з повторної обробки після зварювання для корекції геометрії виробів. Особлива увага приділяється аналізу за методом кінцевих елементів для прогнозування і оптимізації локалізованого теплового натягу з теплоотводом, пов'язаним з джерелом зварювального тепла. Рекомендується вибрати параметри для інженерного рішення. Бібліогр. 21, табл. 1, рис. 15.

*Ключові слова:* залишкова напруга зварювання, низька напруга бездеформаційного зварювання, бухтиноватість, термічний натяг, температурні розтягування, метод кінцевих елементів

## СНИЖЕНИЕ УРОВНЯ БЕЗДЕФОРМАЦИОННЫХ СВАРОЧНЫХ НАПРЯЖЕНИЙ ТЕРМИЧЕСКИМ НАТЯЖЕНИЕМ

ГУАН ЦЯО

Китайская инженерная академия, Пекинский научно-исследовательский институт  
технологии производства авиатехники (BAMTRI). a/я 863, 100024, Пекин, Китай. E-mail: guanq@cal.cn

При изготовлении листовых пластин, панелей и оболочек с помощью сварки деформации продольного изгиба становятся существенными, особенно для аэрокосмических конструкций с толщиной металла менее 4 мм. Для предотвращения потери устойчивости разработаны методы сварки с низким напряжением без деформаций. Эти инновационные методы успешно применяются в производстве аэрокосмических конструктивных компонентов. В статье подробно описаны и обобщены особенности методов сварки с низким напряжением без деформаций с использованием либо полного эффекта термического натяжения поперечного сечения, либо эффекта локального теплового натяжения. Основная идея этих методов сварки заключается в том, чтобы выполнять активное управление процессом характерных пластических (несовместимых) деформаций и напряжений при сварке для получения результатов без деформаций, чтобы не требовалось дорогостоящих операций по повторной обработке после сварки для коррекции геометрии изделий. Особое внимание уделяется анализу по методу конечных элементов для прогнозирования и оптимизации локализованного теплового натяжения с теплоотводом, связанным с источником сварочного тепла. Рекомендуется выбирать параметры для инженерного решения. Библиогр. 21, табл. 1, рис. 15.

*Ключевые слова:* остаточное напряжение сварки, низкое напряжение бездеформационной сварки, бухтиноватость, термическое натяжение, температурные растяжения, метод конечных элементов

Поступила в редакцию 15.05.2018