

EVALUATION OF LOAD BEARING CAPACITY OF CYLINDRICAL SHELL OF ABOVE-GROUND VERTICAL STEEL WELDED TANK FOR OIL STORAGE AFTER REPAIR

ОЦІНКА НЕСУЧОЇ ЗДАТНОСТІ ЦИЛІНДРИЧНОЇ СТІНКИ ВЕРТИКАЛЬНОГО ЗВАРНОГО РЕЗЕРВУАРА ДЛЯ ЗБЕРІГАННЯ НАФТИ ПІСЛЯ РЕМОНТУ

A. Barvinko, Y. Barvinko, A. Yashnik, O. Kostenevich

E.O. Paton Electric Welding Institute of the NAS of Ukraine. 03150, Kyiv, 11 Kazymyr Malevych Str.
E-mail: tanksweld@gmail.com

When above-ground steel tanks are repaired, certain improper techniques used during welding of individual sheets into the tank shell may cause depressions to form in the shell surface. Such deviations in the shell shape from the design geometry create additional stresses. In this study basing on result of computer calculation of tank with $D = 22.8$ m and $H = 12.0$ m it is proposed that if the shell imperfection is a rectangular depression of a near-cylindrical design geometry, it is possible to increase the allowable stresses by 10 % by introducing a specific coefficient taking into consideration the effect of additional stresses. 19 Ref., 3 Tabl., 7 Fig.

В процесі ремонту вертикальних сталевих резервуарів у разі недотримання технології зварювання окремих листів в стінку резервуара можливе утворення відхилень від її проектної геометричної форми. Наявність недосконалостей геометричної форми стінки від проектної призводить до виникнення в ній додаткових напружень. В представленій роботі за результатами досліджень впливу прямокутної недосконалості, геометрична форма якої близька до циліндричної, на напружений стан стінки резервуара РВС-5000 пропонується збільшити допустимі напруження до 10 % шляхом введення спеціального коефіцієнта, що враховує дію додаткових напружень. Бібліогр. 19, табл. 3, рис. 7.

Keywords: vertical cylindrical above-ground tank, stressed state, rectangular depression, local shell deformation, welding, repair

Ключові слова : вертикальний наземний циліндричний резервуар, напружений стан, прямокутне відхилення, локальна деформація стінки, зварювання, ремонт

Introduction. When repairing cylindrical steel oil storage tanks by closed-contour welding of individual sheets into the tank shell, buckling or deformation under extended residual weld stresses may be observed [1]. Depressions may form in the thin-walled cylindrical shell creating under the hydrostatic pressure load additional bending stresses exceeding the yield strength of the material [2, 3] in the areas deviating from the design geometry. This requires reducing the filling height of the tank, which may create technological restrictions at storage plants in situations when the volume needs to be clearly defined, e.g., when the reservoirs used are measuring tanks.

Oil storage tanks are high hazard objects classified as Consequences Class 3 (CC3) [4]. Thus, the problem of assessing strength and stiffness of such tanks is especially important. Particular attention should be paid to the development of a separate approach to assessing the impact of initial imperfections, such as depressions, on the bearing capacity of the cylindrical shell [5–7]. Most research on the bearing capacity of cylindrical steel tank shells that

takes into consideration the initial geometric imperfections [8–10] is aimed at improving the calculation algorithms and assessing the conditions leading to the loss of overall stability. Some studies [11–13] used stress concentration factor to analyze the issue of local strength of a thin-walled cylindrical shell. This approach, however, does not allow estimating the total strength and residual life of the tank shell fully. Another study considered the possibility to reduce bending stress for an isolated depression by reinforcing the structure with vertical ribs and a horizontal stiffening ring [2].

Thus, estimating the load-bearing capacity of a deformed shell is an urgent problem requiring further research. In this study, we propose a refined strength criterion for estimating the influence of shape imperfections, i.e. rectangular depressions, on the general shell strength. The chosen object of study was an above-ground steel tank (diameter $D = 22.79$ m, $H = 11.845$ m) with a single rectangular depression formed in its shell during welding of repair sheets without changing the curvature sign of the shell.

Barvinko A. – <https://orcid.org/0000-0002-5719-0576>, Kostenevich O. – <https://orcid.org/0000-0002-7427-2805>

© A. Barvinko, Y. Barvinko, A. Yashnik, O. Kostenevich, 2022

The depression was caused by insufficient transverse shrinkage compensation in vertical welded joints [14]. This required revising the oil filling height during further operation of the tank.

Design solutions for repairing and defect tolerance assessment. The vertical steel tank (Fig. 1) consisted of a cylindrical shell, a bottom, and a conical panel-frame roof with a central support column. By the time of the repair, the tank had been in operation for 58 years. According to the repair project, it was planned to replace the entire 1st course and the defective section from the 2nd course and to the full height of the shell (Fig. 1). The lower part of the insert from the 2nd to the 5th course was ~ 4.5 m high and was welded to the shell with a vertical flat butt weld, while for the upper part,

which was ~ 5.1 m wide and ~ 5.5 m high, the overlap weld was used.

The tank shell had 8th courses: the height of the first new course was 1.79 m, the height of the other courses was approximately 1.49 m. The total height of the shell was $H = 11,759$ m. The design thickness of the courses from bottom up was 9.2–7.3–7.5–5.7–4.8–4.8–4.9–4.8 mm. The first new course and repair insert were made of non-alloy structural steel St3sp5-sv with min yield strength $R_{ey} = 255$ MPa (analog of S235 steel) steel, while the rest of the courses were made of non-alloy structural steel VSt3sp, with min yield strength $R_{ey} = 210$ MPa (analog of S235 steel). To ensure that the shell was generally stable, 24 L-shaped stringers (L90×10) were installed on its upper courses (VII–VIII), and a stiffening ring made

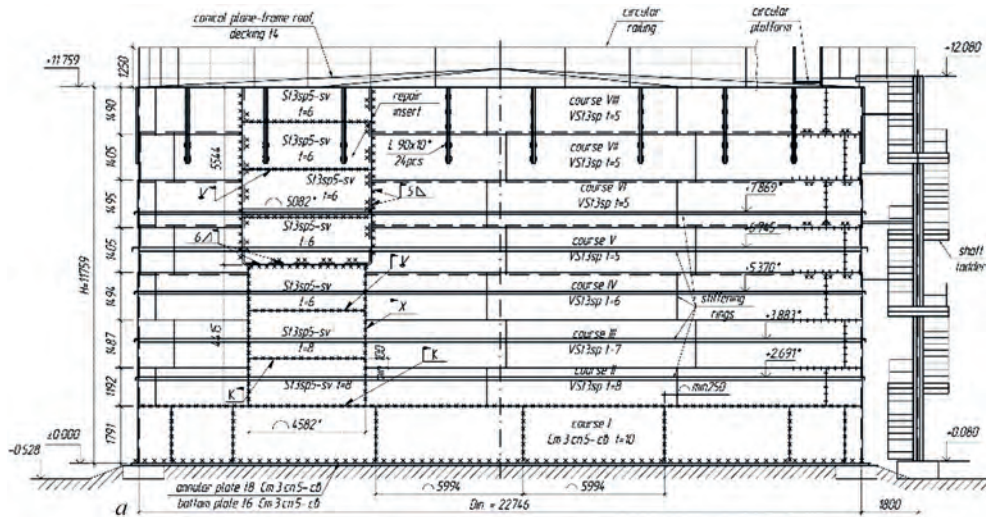

Fig. 1. Process of tank repair: *a* – design schema; *b* – shell after installation stiffening rings, tank is empty

Рис. 1. Процес ремонту резервуара: *a* – технічне рішення із заміни частини стінки; *b* – стінка резервуара після встановлення кільця жорсткості, резервуар пустий

of bent profile L6×90×200 was mounted at the mark +6.745 m.

For welding repair insert it was used the process 135 in the mix M21 with the solid electrode wire G3Si1. Vertical butt welds in insert had X-joint preparation, horizontal welds had X-joint preparation (see Fig. 1). Existing shell welds were welded with using process 121.

A deviation from the vertical weld technology caused the repair insert to deform, which created a depression taking up the full height of the shell characterized by unacceptable [6] vertical deviations (Fig. 2). Estimation of the geometric shape of the deformed shell (local deviations) using a template (straightedge) showed that it met the standard requirements [5, 6].

Eurocode 3 stipulates [15] that in the plastic limit state LS1 (yield strength), the strength analysis for tanks is performed using the circumferential stress:

$$\left[\gamma_F \rho g H_{\text{red}} + p_{\text{Ed}} \right] \left(\frac{r}{t} \right) \leq f_{yd} \quad (1)$$

where r is the radius of the tank; ρ is the density of the stored liquid; g is the free fall acceleration; $H_{\text{red},j} = H_j - 0,3$ m (H_j is the vertical distance from the bottom of the j^{th} course to the filling height level); p_{Ed} is the calculated value of internal pressure; γ_{M0} is the partial resistance factor; $f_{yd} = f_{yk} / \gamma_{M0}$; f_{yk} is the characteristic value of the yield strength.

According to EN14015 [5], when operating a tank, the maximum allowable design stress S of the tank's shell must be 2/3 of the yield strength, but must not exceed 260 MPa. The minimum required shell thickness e_c is determined based on the circumferential stress by the formula:

$$e_c = \frac{D}{20S} \{ 98W (H_c - 0,3) + p \} + c \quad (2)$$

where D is the tank diameter; W is the maximum design density of the product; p is the design internal pressure; c is the corrosion allowance; H_c is the distance from the bottom edge of the course to the filling height.

The API-650 standard describes a similar approach [6].

Thus, when performing strength analysis of the tank shell with imperfections, one needs to consider the action of circumferential and additional stresses.

Let us consider how the depressions formed in the tank shell during its repair affect its stress state. The analysis of these deformations shows that the actual geometric shape of the deformed area of the shell can be viewed as a smooth unfractured rectangular depression 5956 mm wide and 11760 mm high (Fig. 2) with a smooth transition to the cylindrical shell. Since the depression is formed due to insufficient transverse shrinkage compensation in the repair vertical welds [14], it happens largely through the reduction of the insert arc

length. This means that the shell in the depression area deforms in such a way that its radius increases. Thus, the change in the stress state of the cylindrical shell must be mainly contributed by additional bending stresses [16].

In order to reduce the initial deviations from the design geometry, the tank shell was reinforced with four L-shaped stiffening rings (L100×8 mm, L125×8 mm) installed at the marks +2.691 m, +3.883 m, +5.370 m, and +7.869 mm during the filling of the tank. The stiffening rings strengthened the structure, allowing for the general stability of the tank shell. Fig. 2 presents the out-of-plumbness values for the empty tank after the hydrostatic test has been completed and the stiffening rings fixed to the shell.

Computer simulation of the stress-strain state of the tank shell deviating from the design geometry (Fig. 2) was performed by the finite element method (FEM) using the SCAD Office 21.1.9.9 software system. The finite element model of the tank shell consisted of rectangular shell elements taking into consideration geometric nonlinearity. The minimum size of the rectangular finite element was 114.5×122.5 mm. For the lower edge of the shell the fixed-end boundary condition was set, while the boundary condition of horizontal translational motion was set for the top edge of the shell. The fixed roof of the tank was represented by a load evenly distributed along the upper edge of the shell. Stiffening rings and stringers were modeled using end rod elements. The design specific weight of oil was taken as 0.87 t/m³.

To analyze the flat stress state in the tank shell with initial deviations under hydrostatic pressure, we used the von Mises theory [17].

Analytical description of the imperfections in the shell geometry was performed using third order approximation curves according to the study by A.A. Krysko [18]. Fig. 3 shows the results of computer simulation of the tank shell with the depression (the surface imperfections are 10 times magnified for illustrative purposes). The junction between the depression and the cylindrical shell was described by a sinusoidal curve.

Result of numerical research & Discussion. The results on FEM calculations of equivalent (von-Mises) stresses obtained in the middle, inner, and outer shell fibers under hydrostatic pressure load (product density 0.87 t/m³) are presented in Table 1 for two filling heights, $H_f = 9$ m and $H_f = 10$ m, and in Fig. 4, $a-c$ for $H_f = 10$ m. The maximum local equivalent stresses acted at the junctions between the shell and the stiffening rings. To avoid the edge effect in the ring-to-shell junction areas, the stresses in the shell were determined at a distance greater than $0,6(rt)^{1/2}$ from those areas.

The maximum fraction of bending stresses was defined as the ratio of the equivalent stress in the outer ($\sigma_{\text{eq out}}$) or inner ($\sigma_{\text{eq in}}$) shell fibers (whichever the

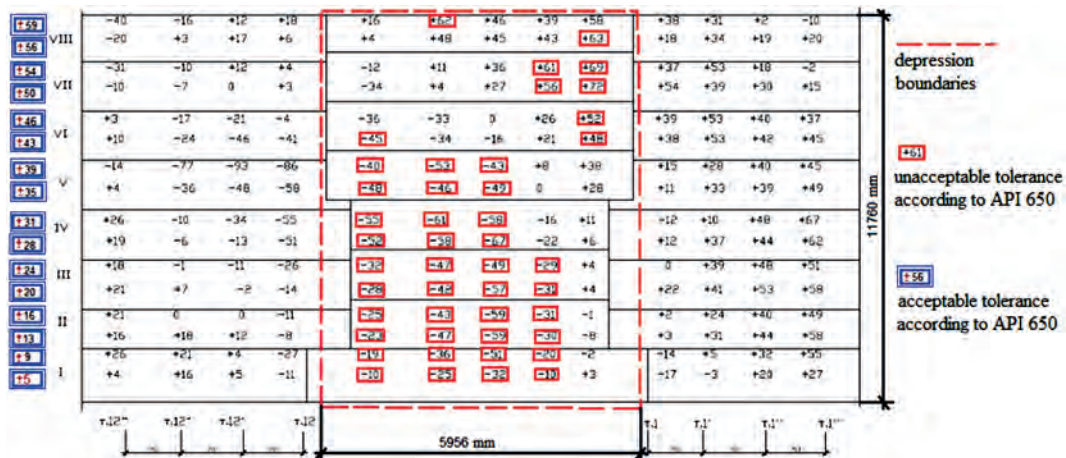

Fig. 2. Size of depression and out-of-plumbness values for tank with installed stiffening rings, «+» outside of tank, «-» inside of tank
 Рис. 2. Розмір відхилення геометричної форми стінки резервуара після встановлення кілець жорсткості: «+» – відхилення на зовні резервуара; «-» – відхилення всередину резервуара

largest) to the equivalent membrane stress in the middle fibers ($\sigma_{eq,m}$), Δ_{eq} , or to the allowable stress (σ_{all}), Δ_{all} . The latter was taken as per API 650 [6]:

$$\sigma_{all} = \min \left\{ \begin{matrix} 0,4f_u \\ 0,67f_y \end{matrix} \right\} = 144 \text{ MPa}, \quad (3)$$

were $f_u = 360 \text{ MPa}$ is ultimate strength; $f_y = 240 \text{ MPa}$ is yield strength, steel St3sp5-sv.

The analysis of the nonlinear calculation results (Fig. 4, a-c, Table 1) shows that deviations from the design geometry cause additional stresses in the outer/inner fibers of the deformed area of the shell.

The highest equivalent stresses in the middle fibers of the shell (equivalent membrane stresses) were observed for the 1st and 2nd courses: $\sigma_{eq,m} = 120 \text{ MPa}$ ($H_f = 9 \text{ m}$) and $\sigma_{eq,m} = 135 \text{ MPa}$ ($H_f = 10 \text{ m}$), the equivalent stresses in the outer fibers were $\sigma_{eq} = 143 \text{ MPa}$ ($H_f = 9 \text{ m}$) and $\sigma_{eq} = 158 \text{ MPa}$ ($H_f = 10 \text{ m}$).

The analysis of the data from Table 1 shows that when the filling height is increased to the design value $H_f = 10 \text{ m}$, the strength condition [6] in the first and second courses is not met (Table 1). Additional

bending stresses in the shell cause the design equivalent stresses σ_{eq} to increase by 10% relative to the allowable values σ_{all} .

In order to substantiate the value of additional bending stresses, let us analyze the stress state of an isolated

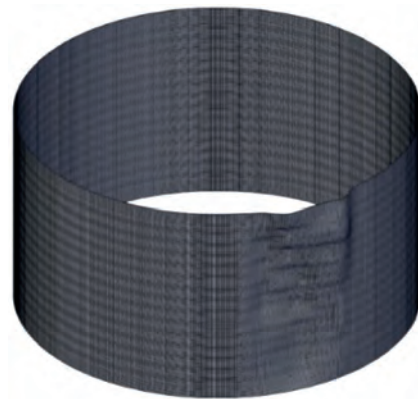

Fig. 3. Tank shell geometry obtained using third order approximation curves [18]. Magnification $\times 10$

Рис. 3. Геометрична форма стінки резервуара із вм'ятиною після комп'ютерного моделювання із використанням апроксимації [18]: збільшення $\times 10$

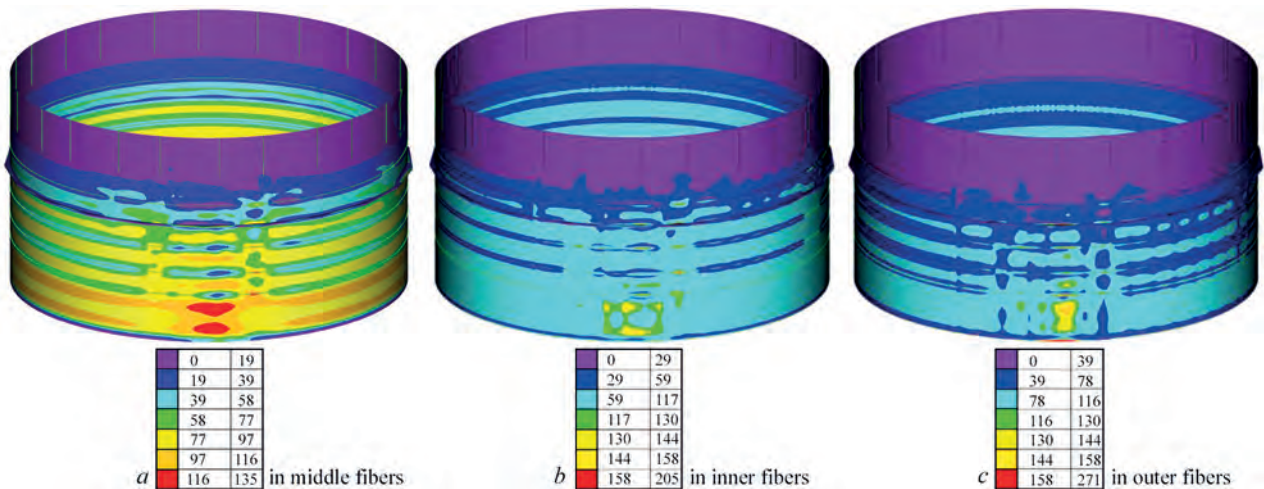

Fig. 4. Equivalent (von Mises) stress σ_{eq} , MPa in shell with rectangular depression formed after repair welding
 Рис. 4. Еквівалентні напруження по Мізесу σ_{eq} , МПа, в стінці з прямокутною недосконалістю, що утворилася після ремонтного зварювання

Table 1. Calculation results on stresses in repair insert courses of steel shell (St3sp-5, S255) of various thickness t for two filling heights H_f
Таблиця 1. Результати розрахунків напруг у ремонтних вставках сталевій оболонки (Ст3сп-5, С255) різної товщини t для двох висот заповнення H_f

Course no.	t , mm	$H_f = 9$ m		$H_f = 10$ m	
		$\sigma_{eq\ mid} / \sigma_{eq\ in} / \sigma_{eq\ out}$, MPa	$\Delta_{eq} / \Delta_{all}$, %	$\sigma_{eq\ in} / \sigma_{eq\ out}$, MPa	$\Delta_{eq} / \Delta_{all}$, %
1	9.2	120/132/143	16/–	134/149/158	15/10
2	7.2	120/136/143	16/–	135/149/158	15/10
3	7.2	100/106/120	17/–	115/122/136	15/–
4	5.4	86/100/102	16/–	104/122/122	15/–
5	5.4	72/80/90	20/–	90/101/100	11/–
6	5.4	44/54/55	20/–	63/76/62	17/–
7	5.4	14/33/40	65/–	32/47/40	32/–
8	5.4	13/20/25	48/–	9/13/12	31/–

Footnote. The edge effect zone at a distance of $0,6(rt)^{1/2}$ (where r is the shell radius) from the bottom edge of the first shell course within the junctions between the shell and the stiffening rings was not considered.

rectangular depression in the cylindrical tank shell considered allowable by the standards [5–7]. The API 650 [6] and EN14015 [5] standards require assessing the geometry tolerance in a deformed shell using a template or a vertical straightedge with a length of 0.9 and 1.0 m.

According to EN14015 [5], the maximum local deformation in the vertical and horizontal directions is checked by a 1.0 m long straightedge (template) and should not exceed 16 mm (for a sheet thinner than 12.5 mm). A similar approach is taken in API 650 [6]. Here, local deviations from the design geometry for vertical and horizontal welded joints should not exceed 13 mm (1/2 inch). Deviations should be determined using a 900 mm (36 inch) template.

Let us consider the stress state of the local deviation from the ideal cylindrical shape on the example of an isolated rectangular depression with a length of 914 mm in the circumferential direction and a maximum depth of 13 mm (Fig. 5, 6), which spreads along the entire tank shell height and is considered allowable as per API 650 [6]. The results of nonlinear calculation of equivalent stress fields according to the von Mises theory in the middle, inner and outer fibers of the tank shell with an isolated 13 mm deep depres-

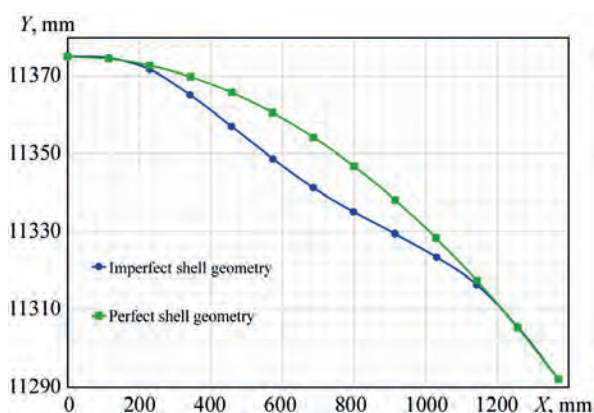

Fig. 5. Approximation of geometric shape rectangular depression with 914 mm wide in tank shell

Рис. 5. Апроксимація геометричної форми прямокутної недосконалості в стінці резервуара шириною 914 мм

sion are shown in Fig. 6 and Table 2. The strength condition assessment was performed according to API 650 [6] (3) and EN14015 [5]:

$$\sigma_{all} = \min \left\{ \begin{array}{l} 0,67 f_y \\ 260 \text{ MPa} \end{array} \right\} = 160 \text{ MPa.} \quad (4)$$

The analysis of the obtained data (Fig. 6, Table 2) shows that, although the 914 mm wide and 13 mm deep depression is deemed acceptable according to the API 650 [6] standard, the cylindrical tank shell with such a deformation, besides the circumferential membrane stresses, also develops sufficiently large additional bending stresses (40...50% of σ_{eq}) in the inner and outer fibers. This means that the presence of such depression does not allow meeting the strength condition for the shell as per the standards [5, 6] (Table 2).

The influence of the length of the 13 mm deep depression in the circumferential direction was also assessed for the depression lengths of 914, 1200 and 1500 mm (Table 3) at a filling height of 10 m.

The analysis of the calculation results (Table 3) shows that even when the width (length) of the de-

Table 2. Calculation results on stresses in tank shell area with 914 mm long and 13 mm deep depression for filling height $H_f = 10$ m
Таблиця 2. Результати розрахунків напруги в області оболонки резервуара з вм'ятиною довжиною 914 мм і глибиною 13 мм для висоти заповнення $H_f = 10$ m

Course no.	t , mm	$\sigma_{eq\ mid} / \sigma_{eq\ in} / \sigma_{eq\ out}$, MPa	Δ_{eq} , %	Strength condition assessment according to	
				API 650	EN14015
1	9.2	106/185/210	43...49	–	–
2	7.2	112/188/204	40...45	–	–
3	7.2	101/173/192	42...47	–	–
4	5.4	96/160/174	40...45	–	–
5	5.4	80/140/149	43...46	+	–
6	5.4	54/102/116	47...53	+	+
7	5.4	25/57/75	56...67	+	+
8	5.4	3/10/7	70...57	+	+

Footnote. The edge effect zone at a distance of $0,6(rt)^{1/2}$ (where r is the shell radius) from the bottom edge of the first shell course was not considered.

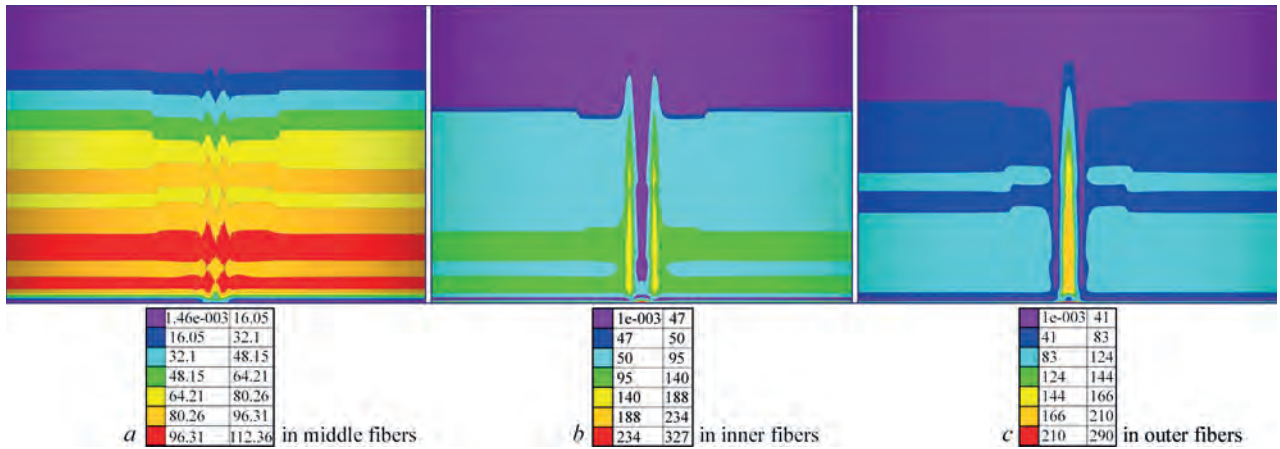

Fig. 6. Equivalent (von Mises) stress σ_{eq} , MPa, in shell with rectangular depression with 914 mm wide
 Рис. 6. Еквівалентні напруження по Мізесу σ_{eq} , МПа, в стінці з прямокутною недосконалістю шириною 914 мм

Table 3. Calculation results on stresses in repair insert courses of tank shell at filling height $H_f = 10$ m for 13 mm deep depressions of different lengths: 914, 1200 and 1500 mm

Таблиця 3. Результати розрахунків напруги в ремонтних вставках оболонки резервуара при висоті заповнення $H_f = 10$ м для поглиблень глибиною 13 мм різної довжини: 914, 1200 і 1500 мм

Course no.	Stresses for following depression sizes:					
	914×13 mm		1200×13 mm		1500×13 mm	
	$\sigma_{eq\ mid}/\sigma_{eq\ in}/\sigma_{eq\ out}$, MPa	Δ_{eq}/Δ_{all} , %	$\sigma_{eq\ mid}/\sigma_{eq\ in}/\sigma_{eq\ out}$, MPa	Δ_{eq}/Δ_{all} , %	$\sigma_{eq\ mid}/\sigma_{eq\ in}/\sigma_{eq\ out}$, MPa	Δ_{eq}/Δ_{all} , %
1	106/185/210	49/46	109/180/162	39/25	109/161/135	32/12
2	112/188/204	45/42	111/180/158	38/25	109/161/134	32/12
3	101/173/192	47/33	96/160/144	40/11	94/142/120	34/-
4	96/160/174	45/21	94/152/130	38/6	92/132/110	30/-
5	80/140/149	46/4	78/126/109	38/-	75/110/90	32/-
6	54/102/116	53/-	49/90/81	46/-	47/78/63	40/-
7	25/57/75	67/-	19/46/47	60/-	18/40/34	55/-
8	3/10/7	70/-	2/6/5	67/-	2/6/5	67/-

pression is increased 1.5 times (to 1500 mm), the stresses in the 1st and 2nd courses of the shell exceed the allowable values by 12%.

This means that it is not always possible to correctly assess geometry tolerance in a deformed shell using a 0.9–1.0 m long template (straightedge), as described in [5, 6], since it may not ensure compliance with the static strength condition in terms of allowable stresses, which should not exceed 2/3 of the yield strength. If the depression in the circumferential direction is shorter than the length of the template, the actual working stresses in the shell can reach the yield strength.

Thus, the analysis of the actual allowable stress state of the tank shell shows that the standards [5, 6] permit the equivalent stresses exceeding the allowable values in a local area with deviations from the design geometry. The stress exceedance in this case is not standardized and thus the local plastic deformation of metal in the outer and inner fibers of these areas is effectively allowed when the tank is filled.

Refined strength criterion for the shell area with a depression. In view of the above, for the rectangular depression in the tank shell close to the design cylindrical shape, certain additional stresses are allowed, provided that the metal of the insert exhibits elastic behavior. It is important to note that under the action of

hydrostatic circumferential and additional stresses, the deformation of the shell is final and does not lead to

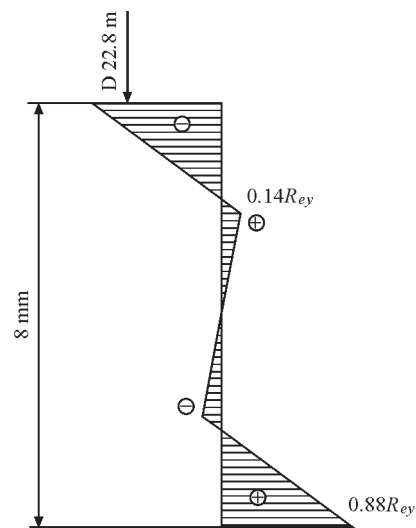

Fig. 7. Residual stresses in the lower course of the tank with a volume of 5000 cub. m ($D = 22.8$ m, $H = 12.0$ m) when constructed by rolling method [19]. Material of shell is non-alloy structural steel VSt3sp, with min yield strength $R_{cy} = 210$ MPa (analog of S235 steel). «+» stretched fiber, «-» compressed fiber
 Рис. 7. Залишкові напруження в нижньому поясі резервуара РВС-5000 ($D = 22,8$ м, $H = 12,0$ м) при його спорудженні методом рулонування [19]. Матеріал стінки ВСт3сп із гарантованою мінімальною міцністю $R_{cy} = 210$ МПа; «+» розтягнуте волокно, «-» – стиснене волокно

the destruction of the tank. A similar situation occurs with tanks constructed from coiled sheets. Here, along with the circumferential stresses, the shell also exhibits its residual bending stresses from folding and unfolding of the roll [19] (Fig. 7). In such a case, the residual bending stress can reach the yield strength of steel.

Thus, considering the above calculation results and the study [16] we propose to formulate the strength condition for the deformed area of the shell as follows:

$$\sigma_{\text{eq}} \leq \gamma_{\text{dep}} S, \quad (5)$$

where σ_{eq} is the equivalent design stresses in the shell; S is the allowable design stress; γ_{dep} is the coefficient determining the value of additional stresses in the depression (insert) relative to the circumferential stresses ($\gamma_{\text{dep}} \leq 1.10$).

The final decision on the possibility of using the tank with initial geometric imperfections should be made and the coefficient γ_{dep} should be determined based on a detailed instrumental inspection of the shell for sharp bends (fractures), corrugations, and areas of plastic deformation, as well as a check of the state of repair welds (angle deformation, results of X-ray inspection or ultrasonic testing, etc.) and their operating conditions (repeated stress mode: quasi-static, low-cycle).

Conclusions

1. When performing the strength assessment of a cylindrical vertical tank shell with a rectangular depression close to the design cylindrical shape, it is proposed to take into consideration the additional stresses caused by this imperfection by introducing an additional coefficient determining the amount of additional stresses in the depression (insert) relative to the circumferential stress.

The value of the additional coefficient should not exceed 10% of the allowable circumferential stress and is determined depending on the actual technical condition of the deformed shell section with repair welds.

2. When developing design solutions for repairing the tank shell, one should use such a repair insert design and such welds design that, in the case of welding technology violation (e.g., insufficient transverse shrinkage compensation in vertical welds), would provide a rectangular depression in the tank shell as close to the design cylindrical shape as possible. In this case, the stress state change will be mainly contributed by additional bending stresses, which can make it possible to increase the allowable stresses and, thus, provide the design filling height of oil (oil product) in the tank.

3. Assessing geometry tolerance in a deformed cylindrical shell using a template (straightedge), as per the standards [5, 6] may be insufficient for ensuring the operability of the tank. In the area with allowable local de-

viations from the design geometry, significant additional stresses may manifest, thus leading to a violation of the strength condition for the tank shell. This may call for an additional calculation analysis of the actual stress state of the cylindrical tank shell for the given imperfection.

References

1. Makhnenko V.I., Barvinko A.Yu., Barvinko Yu.P., Tsiarkovsky P. (2002) Estimation of stressed state of the wall of coiled vertical cylindrical tanks in weld-in of insert plates. *The Paton Welding J.*, 5, 2–6.
2. Šapalas A., Šaučiuvėnas G., Rasiulis K. et al. (2019) Behaviour of vertical cylindrical tank with local wall imperfections. *Journal of Civil Engineering and Management*, 25(3), 287–296. <https://doi.org/10.3846/jcem.2019.9629>
3. Liagova A.A., Samigullin G.H. (2017) Evaluation of stress-strain state of steel cylindrical tank with dent defect. *International Journal of Applied Engineering Research*, 5, 761–764.
4. EN 1990. *Eurocode – Basis of structural design*.
5. EN 14015. *Specification for the design and manufacture of site built, vertical, cylindrical, flat-bottomed, above ground, welded, steel tanks for the storage of liquids at ambient temperature and above*. CEN/TC 265, Secretariat: BSI, (2017-01) 343.
6. API 650 *Welded tanks for oil storage 13th edition*. API, (March 2020).
7. API 653 *Tank Inspection, Repair, Alteration, and Reconstruction*, Fifth Edition. API, (November 2014).
8. Chrysanthos Maraveas, Georgios A. Balokas, K. Tsavdaridis (2015) Numerical evaluation on shell buckling of empty thin-walled steel tanks under wind load according to current American and European design codes. *Thin-Walled Struct.*, 95, 152–160. <https://doi.org/10.1016/j.tws.2015.07.007>.
9. Mahshid Rastgar, Hossein Showkati (2017) Field Study and Evaluation of Buckling Behaviour of Steel Tanks under Geometric Imperfections. *Journal of Applied Mechanical Engineering*, 6(3) (January 2017). DOI: 10.4172/2168-9873.1000268
10. Mahyar Maali, Abdulkadir Cuneyt Aydın, Hossein Showkati et al. (2018) Longitudinal Imperfections on Thin Walled Cylindrical Shells. *J. Civil Environ Eng*, 8:2. DOI: 10.4172/2165-784X.1000309
11. Rasiulis K., Gurkšnyš K. (2010) Analyses of the stress intensity of the cylindrical tank wall at the place of the geometrical defect. *Journal of Civil Engineering and Management*, 16(2), 209–215. <https://doi.org/10.3846/jcem.2010.23>
12. Rasiulis K., Samofalov M., Šapalas A. (2006) Application of the non-linear Fe models to estimate effect of soft defects on thin walls of steel cylindrical tanks. *Ibid*, 12(2), 169–179. <https://doi.org/10.3846/13923730.2006.9636389>
13. Romanenko K., Samofalov M., Šapalas A., Aliphanov L.A. (2004) Linear and Physically Non-linear Stress State Analysis of Local Shape Defects on Steel Cylindrical Tank Walls by Finite Element Method, Lithuania. *Mechanika*, (2) 5–13.
14. EEMUA 159 *Above ground flat bottomed storage tanks: A guide to inspection maintenance and repair* Publication 159 Ed. 5 (2017).
15. EN 1993-4-2 *Eurocode 3: Design of steel structures. Part 4-2: Tanks*.
16. Barvinko A.Yu., Gotsulyak E.A. (2003) Determination of admissible deviation of inserts in replacement of an assembly joint in the wall of coiled tanks. *The Paton Welding J.*, 3, 27–31.
17. EN 1993-1-6: *Eurocode 3. Design of steel structures. Part 1-6: Strength and Stability of Shell Structures*.
18. Krysko A.A. (2016) *Geometric and computer modeling of the exploited structures of thin-walled shells of engineering structures, taking into account the imperfections of the geometric shape*. Donbass National Academy of Civil Engineering and Architecture, PhD thesis (2016) 191.
19. Biletsky, S.M., Golyenko, V.M. (1983) *Industrial production of outsized welded sheet structures*. Kiev, Naukova dumka.

Надійшла до редакції 25.05.2022