

S.A. Khan, T. Mahmood, K.S. Awan

A nature based novel maximum power point tracking algorithm for partial shading conditions

Introduction. The huge demand of green energy over past few decades have drawn the interest of scientists and researchers. Solar energy is the most abundant and easily available source but there have been so many problems with its optimum extraction of output. The factors affecting the maximum power point tracking of PV systems are input irradiance, temperature, load etc. The variations in irradiance level lead to partial shading that causes reduction in performance by not letting system to operate at maximum power point. Many methods have been proposed in literature to optimize the performance of PV systems but each method has shortcomings that have failed all of them. The actual problem occurs when partial shading is very strong; this is where most of the methods totally fail. So proposed work addresses this issue and solves it to the fullest. **The novelty** in the proposed work is that it introduces a new nature-based algorithm that works on the principle of plant propagation. It is a natural optimization technique that plants follow to survive and propagate in different environmental conditions. The proposed method efficiently tracks the global peak under all shading conditions and is simple to implement with high accuracy and tracking speed. **Purpose.** Building an algorithm that can track global peak of photovoltaic systems under all shading conditions and extracts the maximum possible power from the system, and is simple and easy to implement. **Methods.** The method is implemented in MATLAB / Simulink on an electrical model that uses a PV array model. Different shadings are applied to check for the results. **Results.** The results have shown that for different photovoltaic configurations the algorithm performs very good under uniform and partial shadings conditions. Its accuracy, tracking efficiency and tracking time has increased reasonably. **Practical value.** The project can be very beneficial to people as it enhances the performances of PV systems that can make them self-sufficient in electrical energy, focuses on sustainable development and reduces pollution. This way it can have huge impact on human life. References 40, tables 5, figures 18.

Key words: renewable energy, partial shading conditions, maximum power point, global maximum power point, local maximum power point, seeds, runners.

Вступ. Величезний попит на зелену енергію за останні кілька десятиліть привернув увагу вчених та дослідників. Сонячна енергія є найбільш поширеним і доступним джерелом, але мало місце дуже багато проблем з оптимальним отриманням виробленої енергії. Факторами, що впливають на відстеження точки максимальної потужності фотоелектричних систем, є вхідна освітленість, температура, навантаження та ін. Зміни рівня освітленості призводять до часткового затемнення, яке викликає зниження продуктивності, не дозволяючи системі працювати на максимальній точці потужності. У літературі було запропоновано багато методів для оптимізації роботи фотоелектричних систем, але кожен метод має недоліки, які стримують їх використання. Реальні проблеми виникають, коли часткове затемнення дуже сильне; саме в цьому випадку більшість методів демонструють свої найбільші недоліки. Отже, запропонована робота присвячена цій проблемі та вирішує її повною мірою. **Новизна** запропонованої роботи полягає в тому, що вона запроваджує новий природний алгоритм, що працює за принципом розмноження рослин. Це природний метод оптимізації, якому слідує рослини, щоб вижити і розмножуватися в різних умовах навколишнього середовища. Запропонований метод ефективно відстежує глобальний пік за всіх умов затемнення, є простим у реалізації з високою точністю та швидкістю відстеження. **Мета.** Побудова алгоритму, який може відстежувати глобальні піки фотоелектричних систем при всіх умовах затемнення та виділяти з системи максимально можливу потужність, є простим і легким у реалізації. **Методи.** Метод реалізований у MATLAB/Simulink на електричній моделі, яка використовує модель фотоелектричних елементів. Для перевірки результатів застосовуються різні затемнення. **Результати.** Результати показали, що для різних фотоелектричних конфігурацій алгоритм дуже добре працює в умовах рівномірного та часткового затемнення. Його точність, ефективність відстеження та час відстеження значно збільшились. **Практична цінність.** Проект може бути дуже корисним, оскільки він покращує характеристики фотоелектричних систем, що може зробити їх самодостатніми в електроенергетиці, концентрується на сталому розвитку та скорочує забруднення довкілля. Таким чином, це може мати величезний вплив на життя людини. Бібл. 40, табл. 5, рис. 18.

Ключові слова: відновлювана енергія, умови часткового затемнення, точка максимальної потужності, глобальна точка максимальної потужності, локальна точка максимальної потужності, насіння, пагони.

1. Introduction. Immense use of electronic appliances in this era [1], rapid consumption of fossil fuels [2], atmospheric issues, and energy crisis [3] have attracted wide attention toward usage and exploration of renewable energy (RE). But, these sources have the disadvantage of limited storage of the energy and tapping of power. Due to the lacking of storage mechanism, there is a high need for extraction of this abundant energy, especially during day-time [1]. The high yield from these RE sources is obtained only when researchers are able to enhance the efficiencies in both outstanding parameters like conversion and energy storage. The photovoltaic (PV) energy is abundantly available source among RE sources because it is universal, it is easily and freely available, eco-friendly, has less operational and maintenance cost, it is economically attractive for longer duration of time, driving an increasing load with

greenhouse source and technologically expanding in its material usage, and is noiseless [1, 3]. PV systems have been in high demand over the past decade with its total global installation amount of more than 500 GW [4]. Clean electrical energy can be obtained from solar energy using PV arrays. PV arrays are made by making parallel and series combination of PV modules and that make a basic part of PV systems. The PV array has a high nonlinear relation between output current and voltage and it depends mainly on atmospheric conditions like temperature and irradiance. Under uniform conditions the P-V curve contains one peak while multiple peaks appear when in partial shading conditions (PSCs) that includes local peaks (LMPPs) and a global peak (GMPP) [2]. However, the main hinderance for PV panels have been their low energy efficiency because of nonlinearity

© S.A. Khan, T. Mahmood, K.S. Awan

in I-V behavior that has its dependence on atmospheric conditions [3]. Solar PV systems are being controlled with many maximum power point tracking (MPPT) techniques to optimize the output power of PV array. Furthermore, there are many internal and external factors affecting the output efficiency of PV system such as solar irradiation, series and parallel resistance, internal temperature, diode factor, load, PV array surface, shadow, dirt, and so on. For improving efficiency of system, it is imperative to have an MPPT that can improve converter output power efficiency and tracking speed [5]. The output power mainly depends on the parameters like cell temperature (T), irradiation (G) and load connected to it [1]. We know that MPPT matches the operating point and it is usually mounted between PV arrays and converters as shown in Fig. 1.

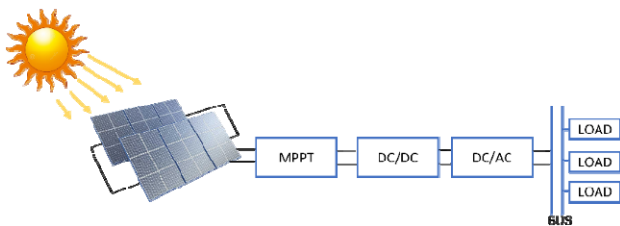

Fig. 1. Solar PV system with MPPT mechanism

Temperature and irradiance levels are utilized by MPPT methods to harvest optimum power from PV system and to determine the output characteristics. Unfortunately, there is a negative effect of non-linear behavior of irradiance and temperature on PV system's efficiency. Due to these reasons, when irradiance is varying the I-V and P-V curves of PV system get multiple peaks on them that are referred as LMPPs and a GMPP. This condition is shown in Fig. 2, 3 [5].



Fig. 2. PV array

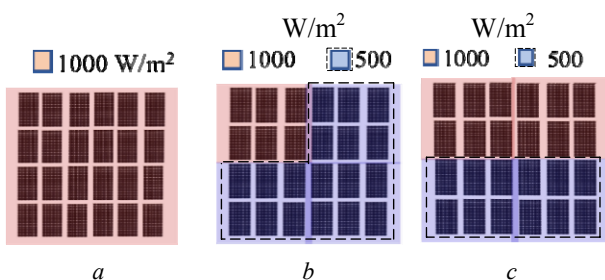

Fig. 3. Shading over a PV array (a) uniform shading (b, c) partial shading

Many MPPTs have been suggested to optimize the PV system's performance, but the confusion occurs when one has to pick one technique for a particular PV system as each method has their merits and demerits [5]. Generally the evaluation criteria for performance of MPPT techniques include accuracy of tracking and a response that is stable at steady and transient state [6]. To

make a successful MPPT technique to work on PV arrays, it's imperative for it to operate at GMPP not LMPP and it should work under varying irradiance conditions [2].

This manuscript is divided into sections as: section 2 describes other MPPT techniques in literature. Section 3 presents the proposed technique, section 4 presents the simulation studies and discussion, and section 5 gives the concluding remarks.

2. Literature review. The work [7] presented a two-step method that is based on the GMPP tracking that tracks more effectively than Particle Swarm Optimization (PSO) in PSCs. But the problem with it is that this is a complex algorithm that makes use of three different methods to look for GMPP and for sudden changes. In [8] C. Huang proposed a technique that tracks the MPP at a faster speed based on a natural cubic-spline-based prediction model and it is incorporated into the iterative search process. The iterative processes are computationally burdening and also since the proposed method is a model-free algorithm that has a demerit that the environmental dynamics can't be judged with it. R.F. Coelho et al. in [9] presented a new method that proposes an MPPT sensor that is temperature based and from the aspect of design it is very sophisticated. This method works on the fact that the voltage of module depends directly on the surface temperature of PV panel. But because of dependence on temperature the effects of irradiation changes and load changes get ignored and ultimately attaining MPPT gets affected. N. Karami et al. in [10] described at least 40 methods that include advanced classical methods for example three-point weight comparison method, parasitic comparison, method, intelligent, and optimized techniques. The methods are not effective enough to be used in all the conditions.

Perturb and Observe (P&O) algorithm is among classical algorithms which uses slope of PV curve to extract the maximum power from the PV panel, but there are oscillations around MPP in the output of the P&O algorithm [11]. The work in [12] presented a method that changes the perturbation steps during transient operation by utilizing a fixed scaling factor with Incremental Conductance (IC) to solve the problems occurred in P&O algorithm. It removes the oscillations that occur around MPP and increases the efficiency. The method still is comparatively more time consuming and hard to implement. In [13] the authors designed an MPPT method that is called delta P&O in which a variable step size is advised to enhance MPP Tracking but oscillations around MPP are still there that causes power fluctuations at steady state. The paper [14] proposed an MPPT technique that perturbs the voltage and the duty cycle but still isn't effective in PSCs and has oscillations around MPP. In [15] another hybrid technique of P&O was proposed that hybridized fuzzy logic with P&O. The performance analysis of the technique has shown some overshoots and oscillations at output. The article [16] proposed a technique that lacks the current-sensor and where PV voltage and cell temperature is measured and from where PV current can be calculated using a look up table [17]. However, this technique is complex and is unreliable because of difficulties in temperature calculation and accuracy in model.

The paper [5] reviewed nearly all necessary and in-stream methods that have been tried to extract MPP under shading conditions. In the category for uniform shading it mentioned some online and offline methods. In online methods, P&O method [18], IC method [19], Hill Climbing (HC) method [20], Beta (β) method [21], Current Sweep (CS) method [22], Constant Current (CC) method [23], Curve Fitting (CF) method [24], Pilot Cell (PC) method [25], Lookup Table (LT) method [26], Load Voltage and Load Current (LV & LC) maximization method [27], and PV output senseless (PVOS) method [28]. All the techniques used for uniform shading have oscillations around MPP which decreases the power and also they can't perform under partial shading conditions. For non-uniform shading conditions, there are many hybrid techniques that have been proposed to serve the purpose of GMPP tracking that include Perturb & Observe with Genetic Algorithm (P&O-GA) [29] & Perturb & Observe with Particle Swarm Optimization (P&O-PSO) [30], Incremental Conductance with Particle Swarm Optimization (INC-PSO) [31], Hybrid Grey Wolf Optimization with Fuzzy Logic Controller (GWO-FLC) [32], Hill Climbing with Adaptive Neuro-Fuzzy Inference System (HC-ANFIS) [33], Modified Hill-Climbing with Fuzzy Logic Control (MHCL-FLC) [34], Improved Artificial Neural Network with Particle Swarm Optimization (IANN-PSO) [35], and Incremental Conductance with Simple Moving voltage Average (INC-SMVA) [36]. The above mentioned methods have been effective in dealing with uniform shading conditions but when shading is strong they fail to track GMPP and stuck at local peaks. The research work [37] proposed Flower Pollination algorithm (FPA) for GMPP tracking in PSCs and [38] utilized FPA and hybridized it with Opposition based Learning (FPA-OBL) that has a great potential of performing under partial shading conditions but this technique gets complicated when implementation is done as it involves a machine learning technique as well.

All above mentioned methods have been effective to some extent to track MPP in uniform shading and GMPP in non-uniform shading conditions but still there is a need of more work and exploration to increase the efficiency and output. The diversity in algorithms is always better as it gives number of choices to adopt a technique on the basis of their merits and demerits. This paper proposes a novel nature inspired algorithm that has been in use for some other scientific purposes [39] but has never been utilized in MPPT. In this paper it has been used for GMPP tracking under uniform and PSCs.

The aim of the paper is development of an algorithm that can track global maximum power point of photovoltaic systems under all shading conditions and extracts the maximum possible power from the system, and is simple and easy to implement.

This research work advises a new technique to attain GMPP of PV arrays in PSCs. The algorithm is naturally inspired by the process of plant propagation specifically the strawberry plant propagation. The proposed technique is a single algorithm and is easily to implement with less parameters, and its approximation strength is so strong that it catches GMPP even in hardest of the irradiance changes. The simulation studies are carried in MATLAB /

Simulink and are compared to other frequently used MPPT algorithms.

3. Proposed technique.

The survival approach of strawberry plant through an adapted propagation strategy:

The plant of strawberry [39] lies in Rose family category. The industry of strawberry fruit started from Paris in the 17th century with its European type. Amedee-Francois Frezier (mathematician and engineer) was hired for drawing South America's Map, when returned from Chile in 1714, brought Chilean type of strawberry plant that has a bigger size fruit. The modern plant is a result of different crossings and evolution.

A. Propagation Strategy

The pure plants generally propagate using seeds, but the most modern hybrid species are infertile that they can't propagate using seeds so they use runners. The runners work in this way: the parent plant send runners or root that when they touch ground, they grow roots from where daughter plants grow. The runners are produced on a principle that follows a reaction to stimuli, for example a stronger plant will grow a concentration of small plants around it but a weaker plant will grow small number of plant but at a longer distance. That means stronger plant which is at a good atmospheric condition i.e., light and humidity, sends short runners but a weak plant which isn't at a good atmospheric condition sends runners less in number but longer in length to look for a good atmospheric condition for its survival. The runners are sent in all directions but more runners are sent towards a better spot. This happens because of what we call tropism or a response of growth to a stimulus [40].

B. Assumptions from Observations

Keeping in view the observations made above, it is supposed that the plant in order to flourish in an atmospheric condition, goes through a survival optimization problem and those who can solve it they survive. The inspiration got from this survival of plant makes us use this approach as an optimization tools that looks for good solutions to an objective function in a solution space and gives best values in the end.

C. Designing an Optimization Problem from Strawberry Plant's Survival Strategy

Let's say the problem to be optimized is:

$$f(x) = \max_{x \in S} Z, \quad (1)$$

where x represents a point in search space S .

The job of survival optimization is to look for the finest position x in the domain S that can provide the finest growth $f(x)$ for the daughter generation.

The Algorithm Strawberry Plant Propagation (SPPA)

The algorithms who search for global optimization usually have two characteristics i.e., concentration and exploration. In concentration, the algorithm searches locally and converges at a local optimum while in exploration it avoids local optimum and goes for global optimum solution. Both these characteristics are conflicting and a successful algorithm will have a balance between them. In strawberry propagation, concentration is implemented by sending short runners in large number to search for good solutions and diversification is

implemented when fewer runners are sent that are longer in length as compared to the solutions that are not at good spot. The pseudo code of algorithm is presented in Fig. 4.

```

Require: objective  $f(x)$ ,  $x \in R^n$ 
Generate a population  $P = \{p_i, i = 1, \dots, m\}$ 
 $g \leftarrow 1$ 
for  $g \leftarrow 1$  to  $g_{\max}$ 
  do
    compute  $N_i = f(p_i)$ ,  $\forall p_i \in P$ 
    sort  $P$  in descending order of  $N$ 
    create new population  $\Phi$ 
    for each  $p_i; i = 1, \dots, m$ 
      do {best  $m$  only}
         $r_i \leftarrow$  set of runners where both the size of the
        set and the distance for each runner (individually) is
        proportional to the fitness  $N_i$ 
         $\Phi \leftarrow \Phi \cup r_i$  {append to population; death occurs by
        omission above}
    end for
     $P \leftarrow \Phi$  {new population}
end for
return  $P$ , the population of solutions
  
```

Fig. 4. The plant propagation algorithm (PPA)

Similar too many other algorithms in nature, SPPA also need some variables, functions and initial values. For SPPA they are a fitness function, population size, number of generations, number of runners and distance if each runner.

The algorithm works on the basis of population of shoots where every shoot in a population is a representative of a solution in the S . Every shoot is supposed that it has grown a root that is similar as the evaluation of an objective function. Every shoot sends out runners to explore S . The number of shoots is denoted by a variable m in the algorithm.

The SPPA is naturally iteration based and at each generation, all shoots send out runner. There is a parameter g_{\max} that gives a termination criteria on the basis of which it is decided that how many times to send out runners.

Solutions are sorted based on their fitness values. The fitness value of runners is dependent on objective function's values, but the real relation among values of objective function and fitness could be modified for a specific problem. However, the SPPA believes that $f(x) \in [0, 1]$; if it doesn't, the equations are needed to be modified that are utilized to decide the numbers of runners and the distance for each. Presented below are some case studies and the actual fitness functions for each case will be presented along with the problem statements.

The number of runners and the distance each runs are determined by the functions that are presented below. The functions have a requirement that the fitness must lie in the range (0, 1). The mapping of fitness value, $f(x)$, is done to satisfy the following equation:

$$N(x) = (\tanh(4 \cdot f(x) - 2) + 1). \quad (2)$$

Figure 5 depicts the effect of mapping function. The necessity of this mapping is described below. This mapping facilitates with a way of finding even more better solutions over less-good ones.

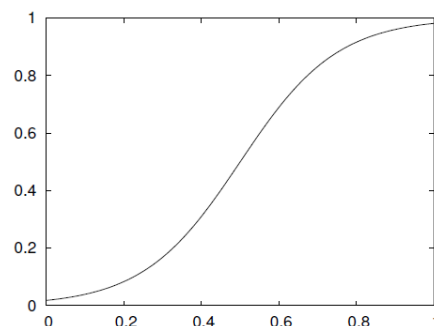

Fig. 5. Effects of mapping function that is used to convert fitness values from [0; 1] to (0; 1) and emphasizing more better solutions

The numbers of runners that are produced are proportional to fitness values. The function used by default is:

$$n_r = [n_{\max} \cdot N_i \cdot r], \quad (3)$$

where n_r represents the numbers of runners generated for the solution i in the present population; n_{\max} gives the max number of runners to be generated; N_i represents the fitness, that is mapped (using (2)), of solution i , and $r \in [0, 1]$ is a random number for every solution in every generation.

Fitness mapping function and ceiling operator when combined make sure that at least one runner is generated by each single solution, and even for the solutions that least in the fittests, and ones that have $f_i(x) = 0$. The n_{\max} number of runners is generated by fittest solutions. And for different studies here, n_{\max} is kept $n_{\max} = 5$. The distance travelled by every runner obeys a same principle. That distance is described as:

$$d_{r,j} = 2 \cdot (1 - N_i) \cdot (r - 0.5), \quad (4)$$

where n is the search space dimension.

For $j = 1, \dots, n$ each $d_{r,j}$ belongs from $(-1, 1)$. It is made sure by the fitness mapping function that the best solutions will possess the capacity to throw runners out at a distance > 0 even if $f_i(x) = 1$. The distance computed will be utilized to renew the solution i on the basis of the bounds on x_j :

$$x_j^* = x_j + (b_j - a_j) \cdot d_{r,j}. \quad (5)$$

The values of x_j^* are managed in such a way that it is made sure that the newly created points are within the limits $[a_j, b_j]$.

4. Simulations, results and discussions. The electrical model used for simulations is shown in Fig. 6 and values of components are listed in Table 1. The PV module used is SunPower SPR-305E-WHT-D and its characteristics are shown in Table 2, 3.

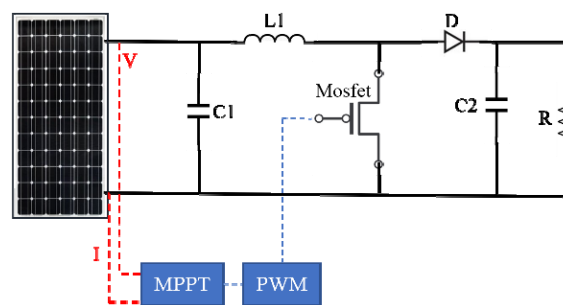

Fig. 6. Electrical circuit for simulation studies

Table 1
Values of electrical components used for simulations

Components	Symbols	Values
Capacitor 1	C1	1×10^{-5} F
Capacitor 2	C2	1×10^{-5} F
Inductor	L1	10×10^{-3} H
Resistor	R	variable Ω

Table 2
Characteristic parameters of SunPower SPR-305E-WHT-D

Parameters	Symbols	Values
Max power	P_{MPP}	305 W
Open circuit voltage	V_{OC}	64.2 V
Short circuit current	I_{SC}	5.96 A
Current at P_{max}	I_{MPP}	5.58 A
Voltage at P_{max}	V_{MPP}	54.7 V
Temp. coefficient of current I_{sc}	K_I	0.06 %/K
Temp. coefficient of voltage V_{oc}	K_V	-0.173 V/K
No. of cells per module	N_S	96

Table 3
Boost converter's parameters

Parameters	Symbols	Values
Device on state resistance	R_{ON}	1×10^{-3} Ω
Snubber resistance	R_S	1×10^6 Ω
Snubber capacitance	C_S	inf F
Forward voltages [device V_f , diode V_{fd}]	V_F	[0, 0] V
Diode forward voltage	V_{fd}	1×10^{-3} V
Current source snubber resistance	R_{is}	inf Ω

The configurations of PV arrays used are 1s1p, 2s1p and 3s1p as shown in Fig. 7. The simulation results for configurations are elaborated separately below.

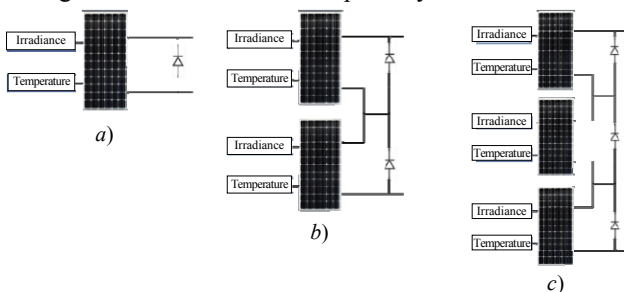

Fig. 7. PV arrays configurations: (a) 1s1p; (b) 2s1p; (c) 3s1p

The simulations done on above configuration are discussed here as:

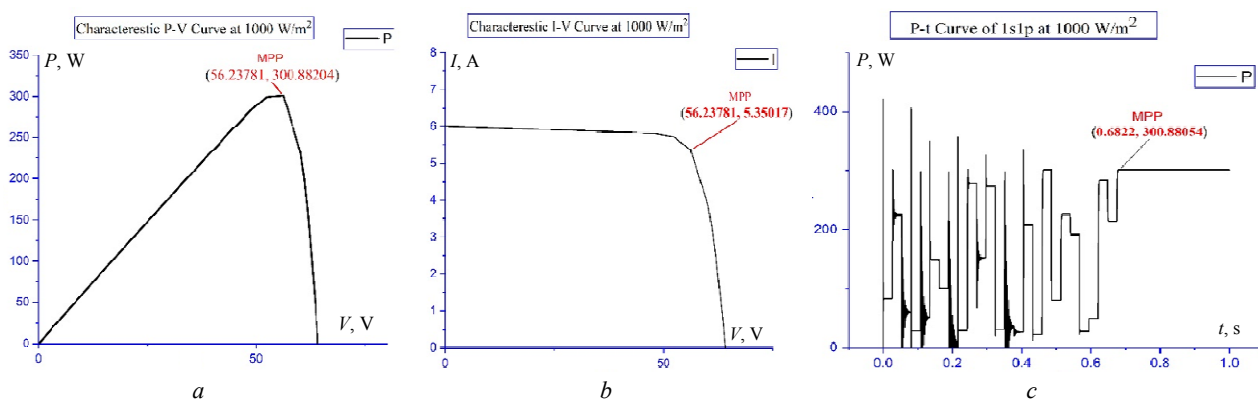

Fig. 8. 1s1p at irradiance of 1000 W/m²:

(a) – characteristic P-V curve; (b) – characteristic I-V curve; (c) – power extracted using proposed method

Configuration 1s1p.

Since 1s1p has only one PV module in it so it can have only uniform shading conditions as in the Fig. 7 is shown. The characteristic curves and power extraction curves using proposed technique for 1s1p are at 100 and 500 W/m² shown in Fig. 8, 9. For 1000 W/m² the rated power is 300.88204 W and power extracted using PPA is 300.88054 W which is 99.99 % efficient in this case.

While for 500 W/m² the rated power is 148.77592 W and extracted power using PPA is 148.67529 W which has an efficiency of 99.93 %. The MPP tracking ability of PPA is very high in uniform shading conditions as it is seen from above discussed results.

Configuration 2s1p.

Figures 10–13 show output results of 2s1p configurations under different shading patterns. Figure 10 shows rated curves and output power curve of 2s1p at 1000, 1000 W/m². The rated power is 605.64547 W and power extracted using PPA is 605.14782 W with efficiency of 99.91 %. Figure 11 shows curves for 1000, 500 W/m² where rated power is 324.38211 W while that extracted using PPA is 323.75138 W, which has an efficiency of 99.8 %. This was partial shading conditions where shading at two PV panels was different that makes shift the MPP and PPA quite accurately tracked MPP.

Figure 12 shows curves for 500, 500 W/m² that has rated power of 301.27333 W while extracted power is 301.04306 W with efficiency of 99.92 %. Similarly, Fig. 13 also shows graphs for rated power and extracted power at 200, 100 W/m². The rated power in that case is 61.74939 W and extracted power is 61.26584 W with efficiency of 99.21 %.

Configuration 3s1p.

Figures 14–18 present characteristic curves and output curves for 3s1p at different shading patterns. Figure 14 shows curves for 1000, 1000, 1000 W/m² where rated power is 912.51031 W while extracted power is 912.16287 W that has an efficiency of 99.95 %.

Figure 15 shows curves for 1000, 750, 500 W/m² where rated power is 496.11087 W and extracted power is 495.49489 W that has an efficiency of 99.87 %.

Figure 16 shows curves for 1000, 750, 750 W/m² where rated power 705.90873 W and extracted power is 705.52431 W with 99.94 % efficiency.

Figure 17 shows curves for 1000, 500, 500 W/m² where rated power is 474.246 W and extracted output power is 474.19434 W with efficiency of 99.98 %.

Figure 18 shows curves for 500, 500, 500 W/m² where rated power 451.81051 W and extracted power is 451.16105 W which has an efficiency of 99.85 %.

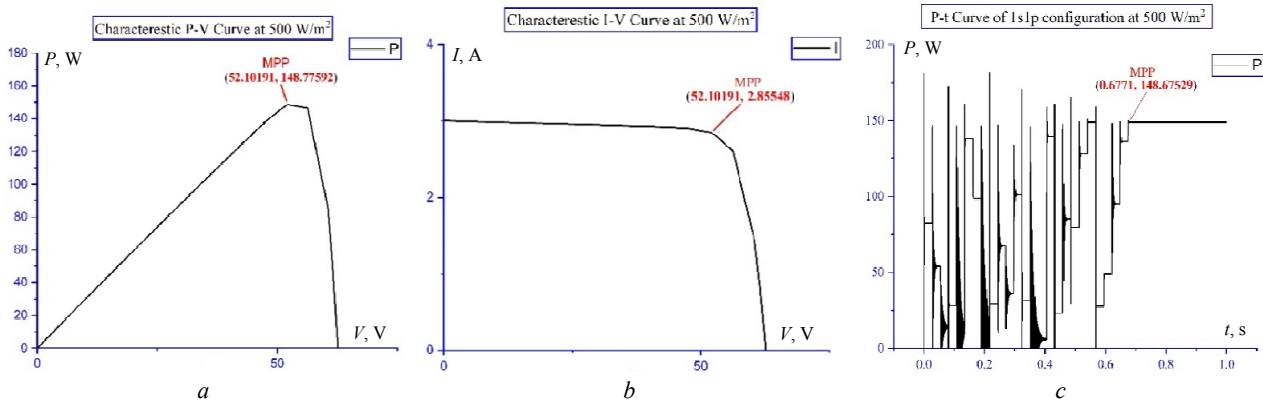

Fig. 9. 1s1p at irradiance of 500 W/m²:
 (a) – characteristic P-V curve; (b) – characteristic I-V curve; (c) – power extracted using proposed method

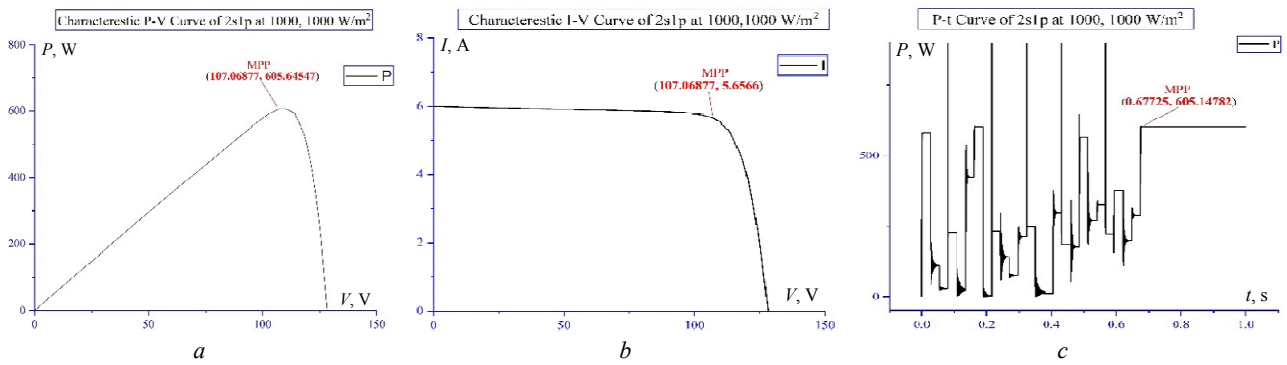

Fig. 10. 2s1p at irradiance of 1000, 1000 W/m²:
 (a) – characteristic P-V curve; (b) – characteristic I-V curve; (c) – power extracted using proposed method

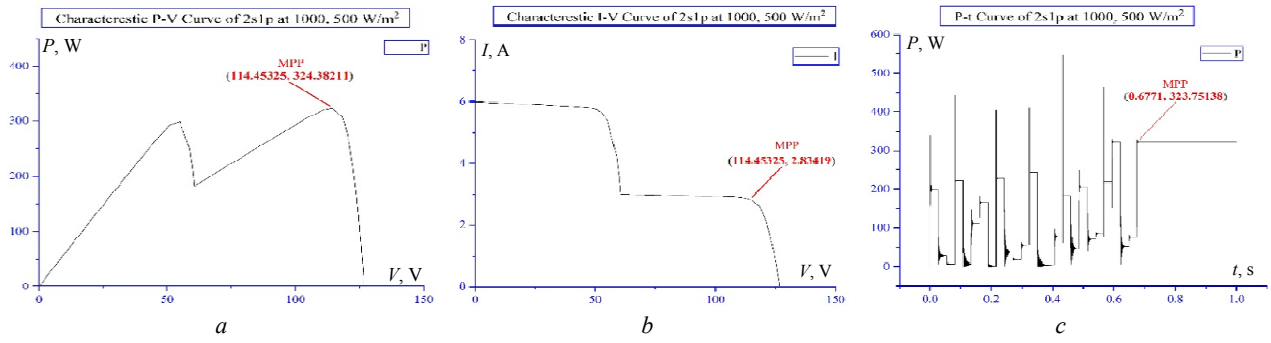

Fig. 11. 2s1p at irradiance of 1000, 500 W/m²:
 (a) – characteristic P-V curve; (b) – characteristic I-V curve; (c) – power extracted using proposed method

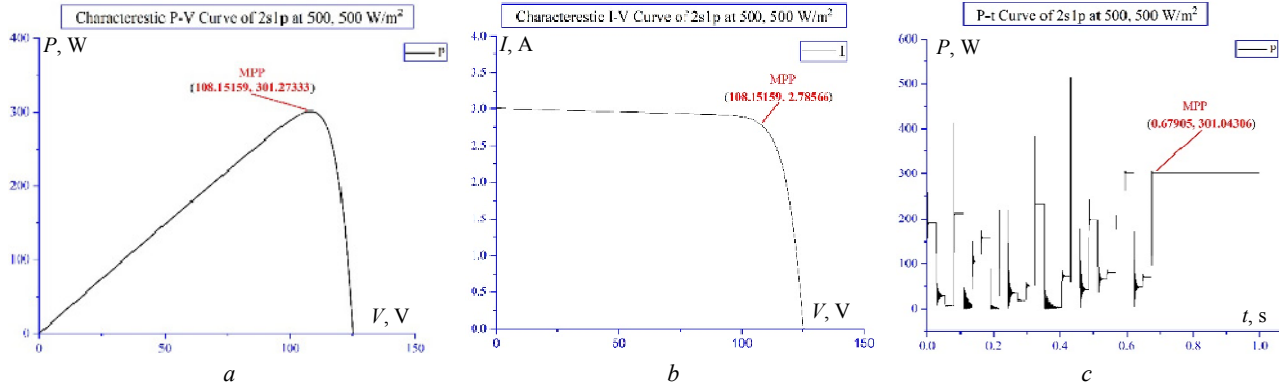

Fig. 12. 2s1p at irradiance of 500, 500 W/m²:
 (a) – characteristic P-V curve; (b) – characteristic I-V curve; (c) – power extracted using proposed method

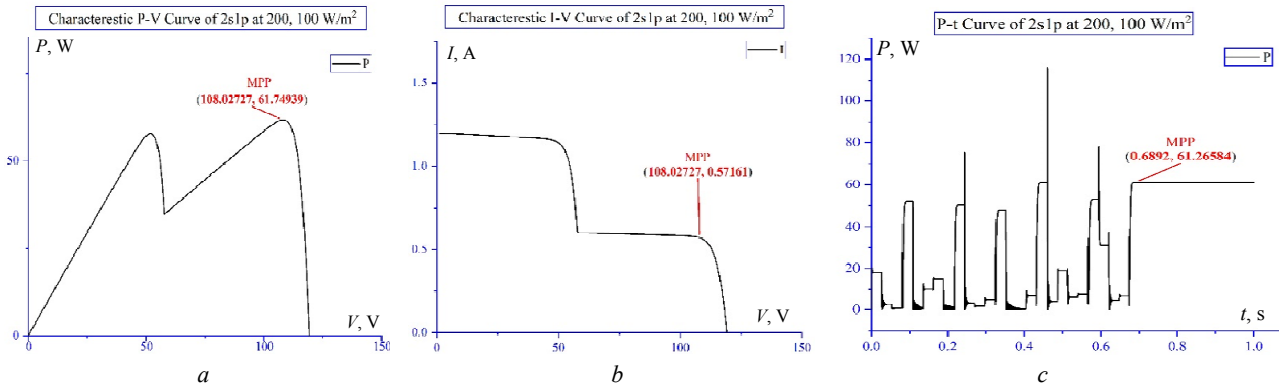

Fig. 13. 2s1p at irradiance of 200, 100 W/m²:
 (a) – characteristic P-V curve; (b) – characteristic I-V curve; (c) – power extracted using proposed method

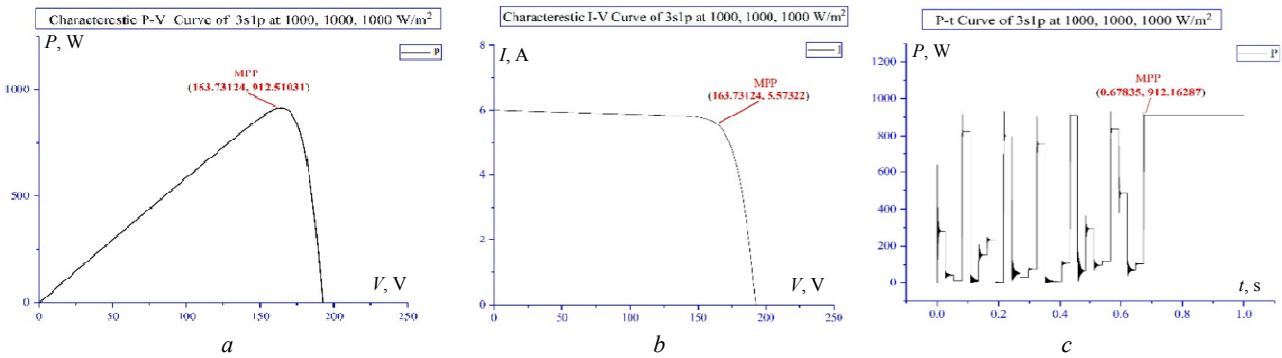

Fig. 14. 3s1p at irradiance of 1000, 1000, 1000 W/m²:
 (a) – characteristic P-V curve; (b) – characteristic I-V curve; (c) – power extracted using proposed method

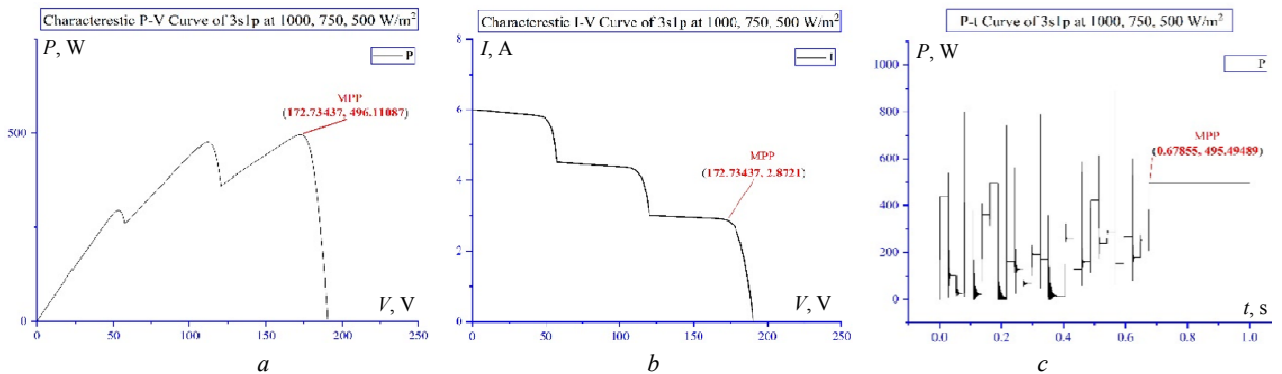

Fig. 15. 3s1p at irradiance of 1000, 750, 500 W/m²:
 (a) – characteristic P-V curve; (b) – characteristic I-V curve; (c) – power extracted using proposed method

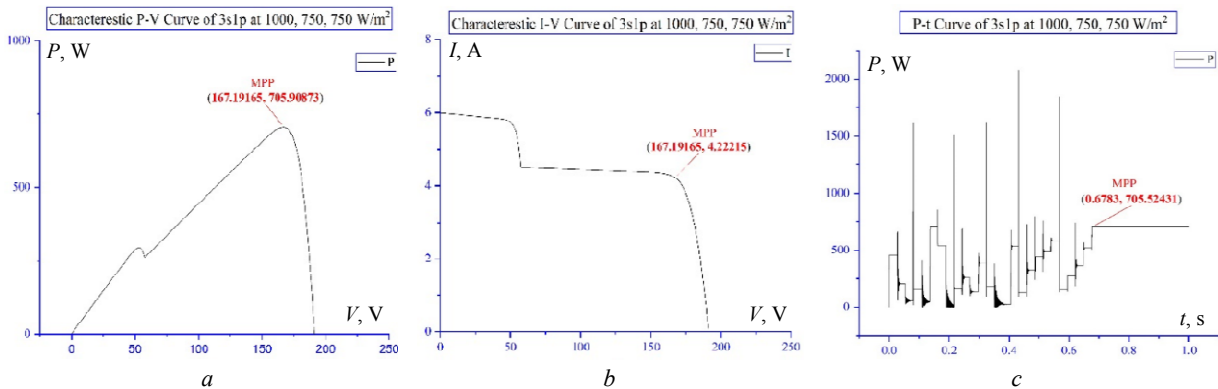

Fig. 16. 3s1p at irradiance of 1000, 750, 750 W/m²:
 (a) – characteristic P-V curve; (b) – characteristic I-V curve; (c) – power extracted using proposed method

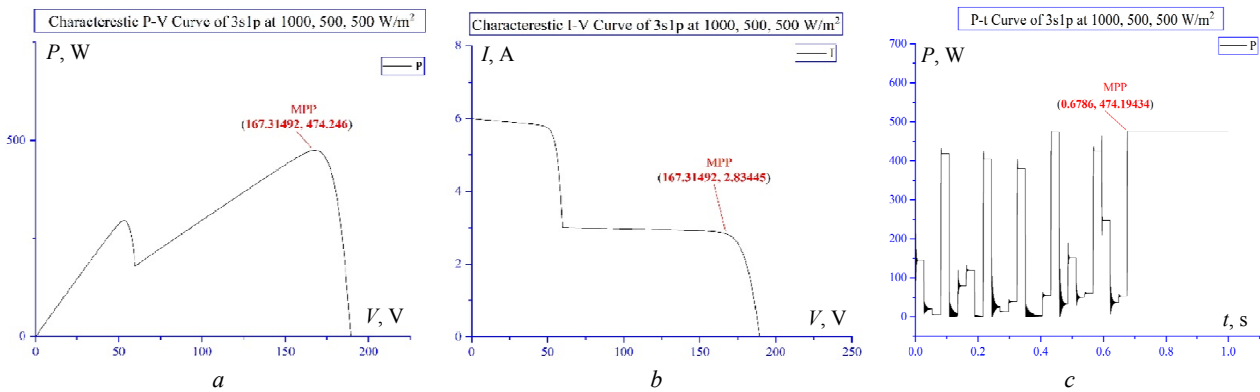

Fig. 17. 3s1p at irradiance of 1000, 500, 500 W/m²:

(a) – characteristic P-V curve; (b) – characteristic I-V curve; (c) – power extracted using proposed method

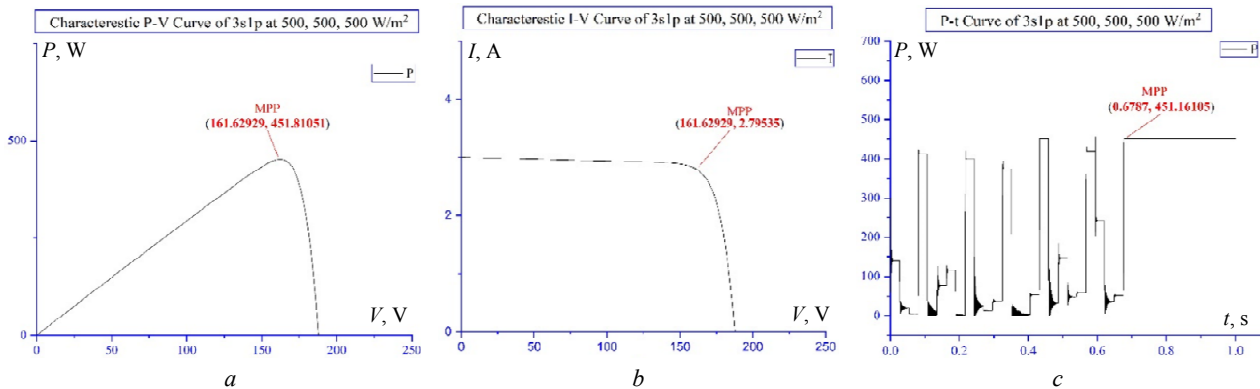

Fig. 18: 3s1p at irradiance of 500, 500, 500 W/m²:

(a) – characteristic P-V curve; (b) – characteristic I-V curve; (c) – power extracted using proposed method

Comparison to other techniques. The most commonly used MPPT algorithms are P&O, HC, IC, PSO, GA, FPA, etc. The algorithms are effective for uniform and weak shading pattern but they fail to track MPP when shading is strong. The FPA-OBL is another technique used for strong shading that has very good MPP tracking ability. The proposed PPA also performs very good under all shading conditions. The simulation results have shown its effectiveness in all shadings. In Table 4 one can see that under strong shading conditions the

efficiency of PPA has been 99.8 % that is the sign of its effectiveness. It is simple and has high MPP tracking and short tracking time. It doesn't have oscillations around MPP. The efficiency of PPA is 99 % in all the cases which makes it very effective and a good choice among other popular methods.

Table 5 shows the brief comparison of techniques.

Table 4

Detailed description of results for all configurations

Config.	Shading patterns, W/m ²	Rated power, W	Extracted power, W	t, s	Efficiency, %
1s1p	1000	300.882	300.880	0.6822	99.99
	500	148.775	148.675	0.6771	99.93
2s1p	1000, 1000	605.645	605.147	0.67725	99.91
	1000, 500	324.382	323.751	0.6771	99.80
	500, 500	301.273	301.043	0.67905	99.92
	200, 100	61.7493	61.2658	0.6892	99.21
3s1p	1000, 1000, 1000	912.510	912.162	0.67835	99.96
	1000, 750, 500	496.110	495.494	0.67855	99.87
	1000, 750, 750	705.908	705.524	0.6783	99.94
	1000, 500, 500	474.246	474.194	0.6786	99.98
	500, 500, 500	451.810	451.161	0.6787	99.85

Table 5

Comparison of Proposed technique with P&O, HC, IC and FPA

Algorithm	Oscillations at MPP	Falling to local maxima	Complexity
P&O	Yes	Yes	Complex
HC	Yes	Yes	Complex
IC	Yes	Yes	Complex
FPA	No	No	Less complex
SPPA	No	No	Less complex

5. Conclusions.

The paper presented a novel technique for maximum power point tracking that is based on the plant propagation technique.

The technique is effective in all type of shading conditions i.e., uniform, weak and strong.

It is a simple, less complex and fast converging technique with lesser number of parameters that has an edge of being easily computable technique as compared to its contemporary techniques.

The simulation studies are carried on MATLAB / Simulink and results are promising in all shading

conditions especially in strong shading conditions. The output efficiency is 99 % plus in all cases and has a tracking time less than 0.7 s in all cases.

Conflict of interest. The authors declare that they have no conflicts of interest.

REFERENCES

1. Bollipo R.B., Mikkili S., P. Bonthagorla K. Hybrid, optimal, intelligent and classical PV MPPT techniques: A review. *CSEE Journal of Power and Energy Systems*, 2021, vol. 7, no. 1, pp. 9-33. doi: <https://doi.org/10.17775/cseejpes.2019.02720>.
2. Li W., Zhang G., Pan T., Zhang Z., Geng Y., Wang J. A Lipschitz Optimization-Based MPPT Algorithm for Photovoltaic System Under Partial Shading Condition. *IEEE Access*, 2019, vol. 7, pp. 126323-126333. doi: <https://doi.org/10.1109/ACCESS.2019.2939095>.
3. Padmanaban S., Priyadarshi N., Sagar Bhaskar M., Holm-Nielsen J.B., Ramachandaramurthy V.K., Hossain E. A Hybrid ANFIS-ABC Based MPPT Controller for PV System With Anti-Islanding Grid Protection: Experimental Realization. *IEEE Access*, 2019, vol. 7, pp. 103377-103389. doi: <https://doi.org/10.1109/ACCESS.2019.2931547>.
4. Metry M., Balog R.S. An Adaptive Model Predictive Controller for Current Sensorless MPPT in PV Systems. *IEEE Open Journal of Power Electronics*, 2020, vol. 1, pp. 445-455. doi: <https://doi.org/10.1109/OJPEL.2020.3026775>.
5. Ali A., Almutairi K., Padmanaban S., Tirth V., Algarni S., Irshad K., Islam S., Zahir M.H., Shafiullah M., Malik M.Z. Investigation of MPPT Techniques Under Uniform and Non-Uniform Solar Irradiation Condition – A Retrospection. *IEEE Access*, 2020, vol. 8, pp. 127368-127392. doi: <https://doi.org/10.1109/ACCESS.2020.3007710>.
6. Abdel-Rahim O., Wang H. A new high gain DC-DC converter with model-predictive-control based MPPT technique for photovoltaic systems. *CPSS Transactions on Power Electronics and Applications*, 2020, vol. 5, no. 2, pp. 191-200. doi: <https://doi.org/10.24295/CPSS/TEEA.2020.00016>.
7. Ghasemi M.A., Foroushani H.M., Parniani M. Partial Shading Detection and Smooth Maximum Power Point Tracking of PV Arrays Under PSC. *IEEE Transactions on Power Electronics*, 2016, vol. 31, no. 9, pp. 6281-6292. doi: <https://doi.org/10.1109/TPEL.2015.2504515>.
8. Huang C., Wang L., Yeung R.S., Zhang Z., Chung H.S., Bensoussan A. A Prediction Model-Guided Jaya Algorithm for the PV System Maximum Power Point Tracking. *IEEE Transactions on Sustainable Energy*, 2018, vol. 9, no. 1, pp. 45-55. doi: <https://doi.org/10.1109/TSTE.2017.2714705>.
9. Coelho R.F., Concer F.M., Martins D.C. A MPPT approach based on temperature measurements applied in PV systems. *2010 IEEE International Conference on Sustainable Energy Technologies (ICSET)*, 2010, pp. 1-6. doi: <https://doi.org/10.1109/ICSET.2010.5684440>.
10. Karami N., Moubayed N., Outbib R. General review and classification of different MPPT Techniques. *Renewable and Sustainable Energy Reviews*, 2017, vol. 68, pp. 1-18. doi: <https://doi.org/10.1016/j.rser.2016.09.132>.
11. Mei Q., Shan M., Liu L., Guerrero J.M. A Novel Improved Variable Step-Size Incremental-Resistance MPPT Method for PV Systems. *IEEE Transactions on Industrial Electronics*, 2011, vol. 58, no. 6, pp. 2427-2434. doi: <https://doi.org/10.1109/TIE.2010.2064275>.
12. Abdourraziq M.A., Maaroufi M., Ouassaid M. A new variable step size INC MPPT method for PV systems. *2014 International Conference on Multimedia Computing and Systems (ICMCS)*, 2014, pp. 1563-1568. doi: <https://doi.org/10.1109/ICMCS.2014.6911212>.
13. Pandey A., Dasgupta N., Mukerjee A.K. High-Performance Algorithms for Drift Avoidance and Fast Tracking in Solar MPPT System. *IEEE Transactions on Energy Conversion*, 2008, vol. 23, no. 2, pp. 681-689. doi: <https://doi.org/10.1109/TEC.2007.914201>.
14. Elgendy M.A., Zahawi B., Atkinson D.J. Assessment of Perturb and Observe MPPT Algorithm Implementation Techniques for PV Pumping Applications. *IEEE Transactions on Sustainable Energy*, 2012, vol. 3, no. 1, pp. 21-33. doi: <https://doi.org/10.1109/TSTE.2011.2168245>.
15. Mohd Zainuri M.A.A., Mohd Radzi M.A., Soh A.C., Rahim N.A. Development of adaptive perturb and observe-fuzzy control maximum power point tracking for photovoltaic boost DC-DC converter. *IET Renewable Power Generation*, 2014, vol. 8, no. 2, pp. 183-194. doi: <https://doi.org/10.1049/iet-rpg.2012.0362>.
16. Elgendy M.A., Zahawi B., Atkinson D.J. Comparison of Directly Connected and Constant Voltage Controlled Photovoltaic Pumping Systems. *IEEE Transactions on Sustainable Energy*, 2010, vol. 1, no. 3, pp. 184-192. doi: <https://doi.org/10.1109/TSTE.2010.2052936>.
17. Samrat P.S., Edwin F.F., Xiao W. Review of current sensorless maximum power point tracking technologies for photovoltaic power systems. *2013 International Conference on Renewable Energy Research and Applications (ICRERA)*, 2013, pp. 862-867. doi: <https://doi.org/10.1109/ICRERA.2013.6749872>.
18. Kumar N., Hussain I., Singh B., Panigrahi B.K. Framework of Maximum Power Extraction From Solar PV Panel Using Self Predictive Perturb and Observe Algorithm. *IEEE Transactions on Sustainable Energy*, 2018, vol. 9, no. 2, pp. 895-903. doi: <https://doi.org/10.1109/TSTE.2017.2764266>.
19. Elgendy M.A., Atkinson D.J., Zahawi B. Experimental investigation of the incremental conductance maximum power point tracking algorithm at high perturbation rates. *IET Renewable Power Generation*, 2016, vol. 10, no. 2, pp. 133-139. doi: <https://doi.org/10.1049/iet-rpg.2015.0132>.
20. Boukenoui R., Bradai R., Mellit A., Ghanes M., Salhi H. Comparative analysis of P&O, modified hill climbing-FLC, and adaptive P&O-FLC MPPTs for microgrid standalone PV system. *2015 International Conference on Renewable Energy Research and Applications (ICRERA)*, 2015, pp. 1095-1099. doi: <https://doi.org/10.1109/ICRERA.2015.7418579>.
21. Jain S., Agarwal V. A new algorithm for rapid tracking of approximate maximum power point in photovoltaic systems. *IEEE Power Electronics Letters*, 2004, vol. 2, no. 1, pp. 16-19. doi: <https://doi.org/10.1109/LPEL.2004.828444>.
22. Tsang K.M., Chan W.L. Maximum power point tracking for PV systems under partial shading conditions using current sweeping. *Energy Conversion and Management*, 2015, vol. 93, pp. 249-258. doi: <https://doi.org/10.1016/j.enconman.2015.01.029>.
23. Anoop K., Nandakumar M. A novel maximum power point tracking method based on particle swarm optimization combined with one cycle control. *2018 International Conference on Power, Instrumentation, Control and Computing (PICCC)*, 2018, pp. 1-6. doi: <https://doi.org/10.1109/PICCC.2018.8384777>.
24. Leedy A.W., Garcia K.E. Approximation of P-V characteristic curves for use in maximum power point tracking algorithms. *45th Southeastern Symposium on System Theory*, 2013, pp. 88-93. doi: <https://doi.org/10.1109/SSST.2013.6524945>.
25. Chandra S., Gaur P., Srishti. Maximum Power Point Tracking Approaches for Wind-Solar Hybrid Renewable Energy System – A Review. In: Singh S., Wen F., Jain M. (eds) *Advances in Energy and Power Systems. Lecture Notes in Electrical Engineering*, 2018, vol. 508. Springer, Singapore. doi: https://doi.org/10.1007/978-981-13-0662-4_1.
26. Esram T., Chapman P.L. Comparison of Photovoltaic Array Maximum Power Point Tracking Techniques. *IEEE*

- Transactions on Energy Conversion*, 2007, vol. 22, no. 2, pp. 439-449. doi: <https://doi.org/10.1109/TEC.2006.874230>.
27. Shmilovitz D. On the control of photovoltaic maximum power point tracker via output parameters. *IEE Proceedings: Electric Power Applications*, 2005, vol. 152, no. 2, pp. 239-248. doi: <https://doi.org/10.1049/ip-epa:20040978>.
28. Shabaan S., Abu El-Sebah M.I., Bekhit P. Maximum power point tracking for photovoltaic solar pump based on ANFIS tuning system. *Journal of Electrical Systems and Information Technology*, 2018, vol. 5, no. 1, pp. 11-22. doi: <https://doi.org/10.1016/j.jesit.2018.02.002>.
29. Sundareswaran K., Vigneshkumar V., Palani S. Development of a hybrid genetic algorithm/perturb and observe algorithm for maximum power point tracking in photovoltaic systems under non-uniform insolation. *IET Renewable Power Generation*, 2015, vol. 9, no. 7, pp. 757-765. doi: <https://doi.org/10.1049/iet-rpg.2014.0333>.
30. Manickam C., Raman G.R., Raman G.P., Ganesan S.I., Nagamani C. A Hybrid Algorithm for Tracking of GMPP Based on P&O and PSO With Reduced Power Oscillation in String Inverters. *IEEE Transactions on Industrial Electronics*, 2016, vol. 63, no. 10, pp. 6097-6106. doi: <https://doi.org/10.1109/TIE.2016.2590382>.
31. Abdulkadir M., Yatim A.H.M. Hybrid maximum power point tracking technique based on PSO and incremental conductance. *2014 IEEE Conference on Energy Conversion (CENCON)*, 2014, pp. 271-276. doi: <https://doi.org/10.1109/CENCON.2014.6967514>.
32. Eltamaly A.M., Farh H.M.H. Dynamic global maximum power point tracking of the PV systems under variant partial shading using hybrid GWO-FLC. *Solar Energy*, 2019, vol. 177, pp. 306-316. doi: <https://doi.org/10.1016/j.solener.2018.11.028>.
33. Lasheen M., Abdel-Salam M. Maximum power point tracking using Hill Climbing and ANFIS techniques for PV applications: A review and a novel hybrid approach. *Energy Conversion and Management*, 2018, vol. 171, pp. 1002-1019. doi: <https://doi.org/10.1016/j.enconman.2018.06.003>.
34. Alajmi B.N., Ahmed K.H., Finney S.J., Williams B.W. Fuzzy-Logic-Control Approach of a Modified Hill-Climbing Method for Maximum Power Point in Microgrid Standalone Photovoltaic System. *IEEE Transactions on Power Electronics*, 2011, vol. 26, no. 4, pp. 1022-1030. doi: <https://doi.org/10.1109/TPEL.2010.2090903>.
35. Sher H.A., Murtaza A.F., Noman A., Addoweesh K.E., Al-Haddad K., Chiaberge M. A New Sensorless Hybrid MPPT Algorithm Based on Fractional Short-Circuit Current Measurement and P&O MPPT. *IEEE Transactions on Sustainable Energy*, 2015, vol. 6, no. 4, pp. 1426-1434. doi: <https://doi.org/10.1109/TSTE.2015.2438781>.
36. Ali A., Li W., He X. Performance Analysis of Incremental Conductance MPPT with Simple Moving Voltage Average Method for Distributed PV System. *The Open Electrical & Electronic Engineering Journal*, 2016, vol. 10, no. 1, pp. 118-128. doi: <https://doi.org/10.2174/1874129001610010118>.
37. Shang L., Zhu W., Li P., Guo H. Maximum power point tracking of PV system under partial shading conditions through flower pollination algorithm. *Protection and Control of Modern Power Systems*, 2018, vol. 3, no. 1, art. no. 38. doi: <https://doi.org/10.1186/s41601-018-0111-3>.
38. Awan K.S., Mahmood T., Shorfuzzaman M., Ali R., Mehmood R.M. A Machine Learning Based Algorithm to Process Partial Shading Effects in PV Arrays. *Computers, Materials & Continua*, 2021, vol. 68, no. 1, pp. 29-43. doi: <https://doi.org/10.32604/cmc.2021.014824>.
39. Salhi A., Fraga E.S. Nature-Inspired Optimisation Approaches and the New Plant Propagation Algorithm. *Proceedings of the International Conference on Numerical Analysis and Optimization (ICeMATH '11)*, Yogyakarta, Indonesia, 2011. Available at: <http://repository.essex.ac.uk/9974/> (accessed 26 May 2021).
40. Gilroy S., Masson P.H. *Plant Tropisms, 1st ed.* Blackwell Publisher, Ames, IA, USA, 2008. Available at: [https://www.cell.com/current-biology/pdf/S0960-9822\(08\)00179-6.pdf](https://www.cell.com/current-biology/pdf/S0960-9822(08)00179-6.pdf) (accessed 26 May 2021).

Received 03.09.2021
Accepted 31.10.2021
Published 03.12.2021

Shayan Ali Khan¹, MSc Student,
Tahir Mahmood¹, Professor,
Kamran Sadiq Awan², PhD Student,
¹Department of Electrical Engineering,
University of Engineering and Technology,
Taxila 47050, Pakistan,
e-mail: shayan.alikhan@yahoo.com,
tahir.mehmood@uettaxila.edu.pk
²Department of Electrical & Electronic Engineering,
Newcastle University,
NE1 7RU, Newcastle Upon Tyne, United Kingdom,
e-mail: k.s.awan2@newcastle.ac.uk (Corresponding author)