



HEAT-PROTECTING PROPERTIES OF THERMAL SPRAY COATINGS CONTAINING QUASI-CRYSTALLINE ALLOY OF THE Al–Cu–Fe SYSTEM

A.L. BORISOVA, Yu.S. BORISOV, E.A. ASTAKHOV, A.P. MURASHOV,
A.N. BURLACHENKO and T.V. TSYMBALISTAYA
E.O. Paton Electric Welding Institute, NASU, Kiev, Ukraine

Given are the investigation results on heat-protecting properties of plasma and detonation coatings (two-layer and graded), in which ZrO_2 stabilised by Y_2O_3 is used as a ceramic component, and alloy Al–Cu–Fe containing the quasi-crystalline ψ -phase is used as a metallic component.

Keywords: *plasma spraying, detonation spraying, zirconia, Al–Cu–Fe system quasi-crystalline alloy, thermal barrier coatings, internal combustion engine components*

One of the current ways of increasing the operating efficiency of gas turbine and diesel engines and extending service life of their components is to use thermal barrier coatings (TBC) [1–4], which found practical application in gas turbine engines (GTE). In this case a conventional structure of TBC consists of three layers: NiCrAlY used as a bond coat and providing adhesion of TBC to a component surface and its oxidation protection at working temperatures of 900–1100 °C, Al_2O_3 used as an interlayer acting as a barrier for diffusion of oxygen to the bond coat and providing adhesion of ceramics to the heat-resistant bond coat, and external layer ZrO_2 – Y_2O_3 characterised by heat-insulating properties. Such coatings are deposited by using the atmospheric plasma spraying, decreased-pressure plasma spraying and electron beam evaporation methods [1, 5]. Heat-resistant nickel and iron alloys are employed as materials of the GTE components.

Diesel engines are another application field for TBCs. Service conditions and goals of these coatings in diesel engines differ from those in GTE. For instance, the temperature of heating of the combustion chamber components in diesels is 350–400 °C. Application of the TBCs the gas temperature in the combustion chamber to be increased to 850–900 °C, this providing a complete combustion of fuel, decrease in its consumption (by 15–20 %) and increase in the engine power (by 8 %) [3, 6].

The most important problem whose solution is related to application of TBCs in diesel engines is to increase the ecological efficiency of their operation by reducing emissions into atmosphere. As proved by the investigation results, the emissions can be reduced by 10–11 % [7]. At present the urgency of this problem grows because of toughening of the requirements to reduction of the emissions, this being attributed to a

change to the new, Euro VI index [8]. A difference of TBCs in diesel engines also lies in a composition of structural materials of the diesels, where aluminium and titanium alloys are used to an increasing extent.

The main method for deposition of TBCs on the surfaces of the combustion chambers of diesels is plasma spraying. Conditions for formation of TBCs and their operation on the surface of such materials differ from those on heat-resistant alloys of the GTE components. The said differences in service conditions of TBCs for GTE and diesel engines make its necessary to use for the latter the top heat-insulating layers of a larger thickness (up to 1 mm or thicker) and change requirements to the bond coat material, which does not have to resist high-temperature oxidation and creep, as is the case of coatings of the Me–Cr–Al–Y system [1, 2, 6].

Therefore, development of the new compositions of TBCs for application under conditions of operation of diesel engines and the technology for their deposition on the surface of aluminium and titanium alloys is a pressing problem for this engineering area.

Alloys with a quasi-crystalline structure, and first of all alloys of the Al–Cu–Fe system, are of high recent interest to researchers and production engineers [9–11]. For example, alloy $Al_{63}Cu_{25}Fe_{12}$, which corresponds in chemical composition to the region of existence of the quasi-crystalline ψ -phase, has such characteristics as low thermal conductivity ($1\text{--}2\text{ W}\cdot\text{m}^{-1}\cdot\text{K}^{-1}$), high values of linear thermal expansion coefficient (LTEC) ($1\cdot 10^{-5}\text{ K}^{-1}$) [12] and hardness (up to 10 GPa) [13], elastic recovery ability ($H/E < 0.02$), corrosion resistance in many aggressive environments [14–17], heat resistance to a temperature of 500 °C [18–21] and wear resistance [22–25]. All this allows an assumption that coatings of the Al–Cu–Fe system alloy can be applied as a binder interlayer in TBCs with ZrO_2 , including for aluminium alloys. This quasi-crystalline alloy is close to ZrO_2 in thermal conductivity, this decreasing the level of internal stresses between



Table 1. Parameters of plasma spraying of TBCs

Coating composition	Current, A	Voltage, V	Argon flow rate, l/min	Spraying distance, mm
AlCuFe	500	30	25	130–140
NiCrAlY	500	30	25	130–140
50 % AlCuFe + 50 % ZrO ₂	500	50	25	110–120
50 % NiCrAlY + 50 % ZrO ₂	500	60	25	110–120
ZrO ₂	500	60	25	110–120

the layers of a bond coat and ceramic coating, while in LTEC equal to $(14-18) \cdot 10^{-6} \text{ K}^{-1}$ it is compatible with the protected components of aluminium alloys (their LTEC is $(20-24) \cdot 10^{-6} \text{ K}^{-1}$), which should lead to decrease in residual stresses at an interface with the substrate and increase in adhesion strength.

Parameters of thermal spraying of coatings of the Al–Cu–Fe system alloy on different metals, including aluminium, and properties of such coatings have been much studied recently [11].

The key characteristics of the coatings (hardness, thermal conductivity, corrosion and wear resistance, etc.) have been found to depend on the phase composition of a sprayed layer, and first of all on the content of the quasi-crystalline ψ -phase.

Dependence of quasi-crystallinity of the sprayed coatings on the temperature conditions of their formation is related to the fact that size of a region of existence of the quasi-crystalline ψ -phase on the phase equilibrium diagram depends on the temperature. As the temperature decreases, the region of the ψ -phase becomes narrower, this being accompanied by widening of the neighbouring region of the approximant crystalline phase as a result of slight displacements of atoms. At the same time, the approximant phases located near the boundaries of existence of the quasi-crystalline phase can have the same properties (including thermal-physical ones) as quasi-crystals [26].

This study presents results of investigations of heat-protecting properties of plasma and detonation coatings with different structures (two- and multi-layer, graded), in which partially stabilised zirconia (ZrO₂ + 7 % Y₂O₃) is used as a material of the protecting ceramic layer, and also such materials as alloys AlCuFe containing the quasi-crystalline ψ -phase and AlCuFeTiCrSi containing the approximant α -phase

are used as a bond coat material, along with traditional heat-resistant alloy NiCrAlY.

Heat-protecting properties of the coatings were investigated on a rig with specimens directly heated by the flame jet of gas torch GN-2. The C₃H₈ and O₂ mixture was used as a combustible. The torch was placed at a distance of 50–60 mm from the surface of a specimen. The specimens were heated for 5 s and then cooled for 30 s by compressed air.

A thermocouple was calked to a depth of 2 mm in a 30 mm diameter and 3 mm thick specimen with an aluminium alloy coating on the opposite side to the coating to measure the heating-cooling process dynamics. The temperature was measured with digital multimeter UT70B. The measurement range of the instrument was 40–1000 °C, resolution was 1 °C, and error depending on the measurement range was 1–3 %. Up to 10 heating-cooling cycles were conducted for each type of the coatings. The maximal temperature of an uncoated specimen regulated by the distance to it and by the thermal power of the torch was approximately 400 °C. That corresponded to the working temperature of components of a piston group of internal combustion engines (ICE) manufactured from aluminium alloys [3].

Heat-protecting properties of the coatings sprayed by the detonation and plasma methods using AlCuFe powders containing the quasi-crystalline ψ -phase and 75 % AlCuFe + 25 % TiCrSi powder mixture containing the approximant α -phase, as well as of the two-layer coatings with the ceramic thermal barrier layer of ZrO₂ and metallic bond coat of NiCrAlY or AlCuFe, and of the three- and five-layer (graded) coatings of the above components were investigated. In this case the task was to establish dependence of the efficiency of heat-protecting properties of the thermal spray coatings on such factors as a spraying method, structure

Table 2. Parameters of detonation spraying of TBCs

Coating composition	Flow rate of working gases, m ³ /h			Layer thickness per shot, μm	Spraying distance, mm
	C ₃ H ₈	O ₂	N ₂		
AlCuFe	1.15	0.5	0.4	10–12	110
NiCrAlY	1.15	0.5	0.4	10–12	110
50 % AlCuFe + 50 % ZrO ₂	0.50	2.0	–	6–8	110
50 % NiCrAlY + 50 % ZrO ₂	0.50	2.0	–	6–8	110

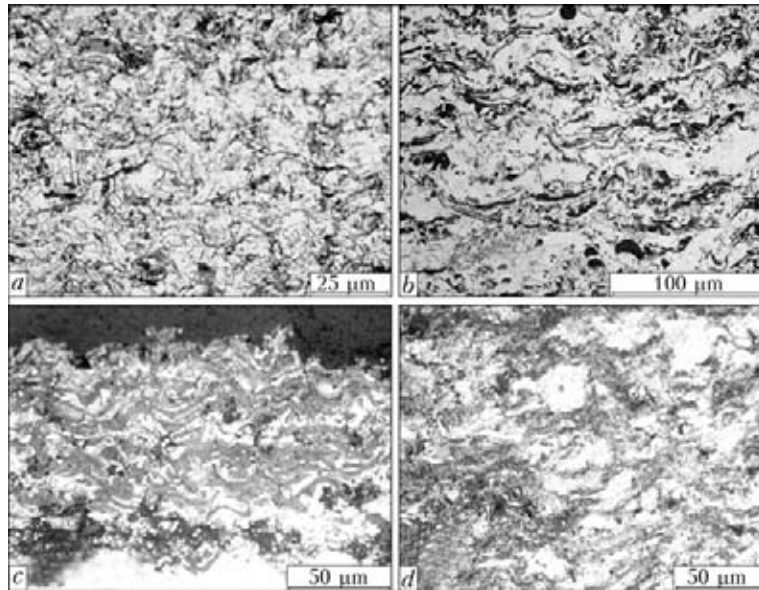

Figure 1. Microstructures of one-layer plasma (*a, c*) and detonation (*b, d*) coatings sprayed from $Al_{63}Cu_{25}Fe_{12}$ (*a, b*) and 75 % $Al_{63}Cu_{25}Fe_{12}$ + 25 % $Ti_{60}Cr_{32}Si_8$ (*c, d*) powders

and phase composition of a coating, and thickness of a sprayed layer.

The coatings were deposited by using process parameters identified from the results of studies [27–29] dedicated to investigation of structure and phase com-

position of thermal spray AlCuFe coatings containing the quasi-crystalline phase (Tables 1 and 2).

Figures 1–3 show typical structures of some of the investigated coatings, and Figure 4 shows heating–cooling cyclograms for uncoated specimens 1 and for

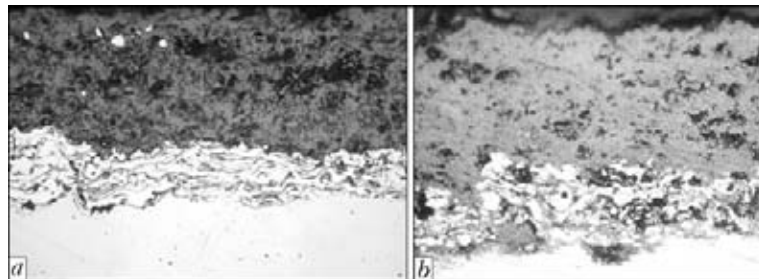

Figure 2. Microstructures ($\times 200$) of two-layer coatings: *a* – plasma coating NiCrAlY– ZrO_2 ; *b* – detonation coating AlCuFe– ZrO_2

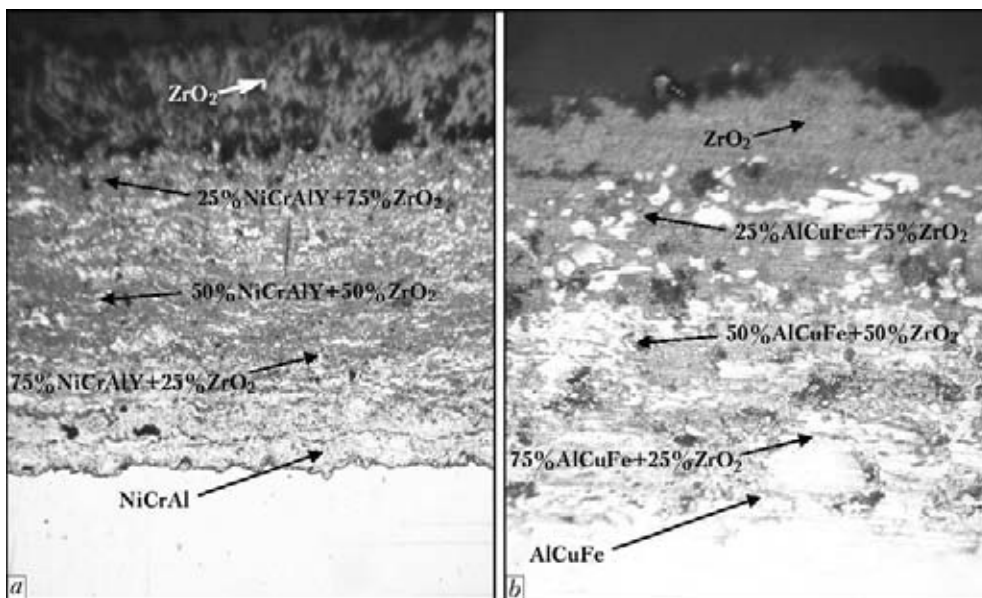

Figure 3. Microstructures ($\times 100$) of graded thermal spray coatings: *a* – detonation coating NiCrAlY–(75 % NiCrAlY + 25 % ZrO_2)–(50 % NiCrAlY + 50 % ZrO_2)–(25 % NiCrAlY + 75 % ZrO_2)– ZrO_2 ; *b* – plasma coating AlCuFe–(75 % AlCuFe + 25 % ZrO_2)–(50 % AlCuFe + 50 % ZrO_2)–(25 % AlCuFe + 75 % ZrO_2)– ZrO_2

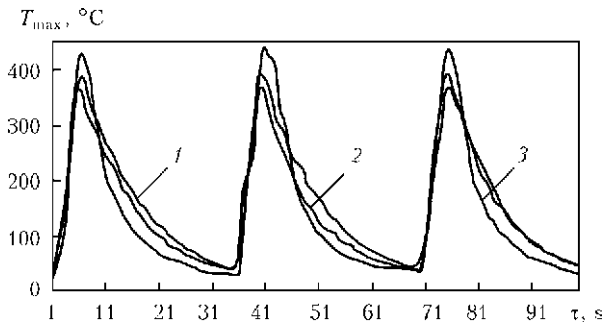

Figure 4. Cyclogram of heating and cooling of aluminium alloy specimens without coating (1) and with AlCuFe coating deposited by plasma (2) and detonation (3) methods (coating thickness – 400 μm , content of the quasi-crystalline ψ -phase – 60 %)

specimens with the Al–Cu–Fe system alloy coatings produced by the plasma 2 and detonation 3 methods. Analysis of the cyclograms allowed evaluating the effect of such parameters as a spraying method, thickness of the sprayed layer and content of the quasi-crystalline ψ -phase in a coating (Figure 5) on the efficiency of heat protection provided by coatings of identical compositions.

Allowing for the level of T_{max} , the content of the ψ -phase in initial AlCuFe powders exerts the most substantial effect on the efficiency of heat protection, the value of the above indicator being up to 60 wt.% (see Figure 5). Transition to application of AlCuFe powders containing 80 % of the ψ -phase (at thickness of the AlCuFe coating equal to $(800 \pm 100) \mu\text{m}$) has almost no influence on the level of T_{max} .

At the same time, evaluation of the effect of thickness of the AlCuFe coating on its heat-protecting prop-

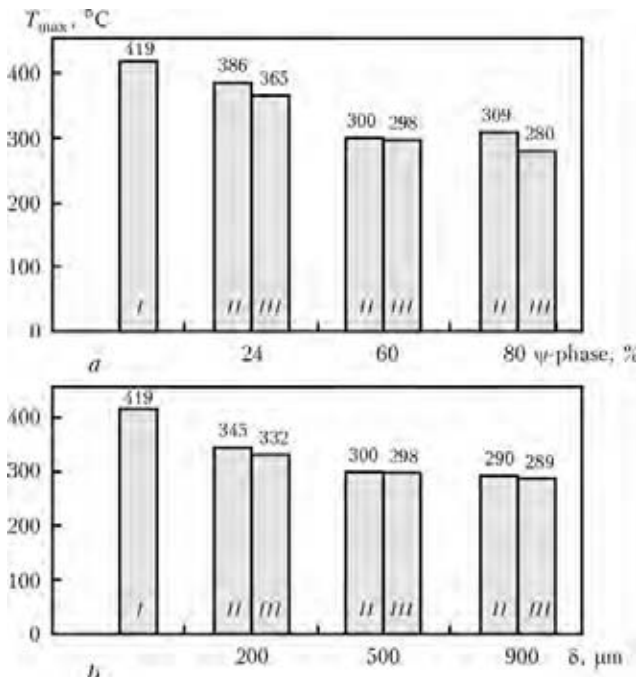

Figure 5. Efficiency of heat protection by the thermal spray ($800 \pm 100 \mu\text{m}$ thick coating sprayed from the $\text{Al}_{63}\text{Cu}_{25}\text{Fe}_{12}$ powder depending on the content of the ψ -phase in the initial powder (a) and thickness of the sprayed layer at a ψ -phase content of 60 % in the initial powder (b): I – without coating; II – detonation coating; III – plasma coating

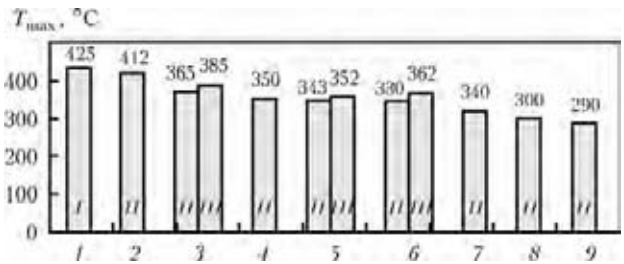

Figure 6. Efficiency of heat protection by plasma and detonation coatings: 1 – without coating; 2 – NiCrAlY; 3 – AlCuFe; 4 – NiCrAlY + ZrO_2 ; 5 – NiCrAlY + (50 % NiCrAlY + 50 % ZrO_2); 6 – AlCuFe + (50 % AlCuFe + 50 % ZrO_2); 7 – NiCrAlY + (75 % NiCrAlY + 25 % ZrO_2) + (50 % NiCrAlY + 50 % ZrO_2) + (25 % NiCrAlY + 75 % ZrO_2) + ZrO_2 ; 8 – AlCuFe + (75 % AlCuFe + 25 % ZrO_2) + (50 % AlCuFe + 50 % ZrO_2) + (25 % AlCuFe + 75 % ZrO_2) + ZrO_2 ; 9 – AlCuFeTiCrSi + (75 % AlCuFeTiCrSi + 25 % ZrO_2) + (50 % AlCuFeTiCrSi + 50 % ZrO_2) + (25 % AlCuFeTiCrSi + 75 % ZrO_2) + ZrO_2 (see designations I–III in Figure 5)

erties (Figure 6) showed that this effect decreases with increase in thickness from 200 to 900 μm . Decrease in the T_{max} level compared to that of the uncoated specimens per 100 μm of the coating thickness is 37.0–43.5 $^{\circ}\text{C}$ at a coating thickness of 200 μm , 23.8–24.0 $^{\circ}\text{C}$ at a coating thickness of 500 μm , and 14.3 $^{\circ}\text{C}$ at a coating thickness of 900 μm . It was established that the AlCuFe plasma coatings compared to the detonation ones provide a more efficient protection of the substrate from heat flows, this most likely being associated with a lower content of the ψ -phase in the latter. This is caused by a more intensive oxidation of material of the spraying particles, the size of which in detonation spraying is 1.5–2 times smaller than in plasma spraying.

The efficiency of heat protection by the thermal spray coatings depending on the composition and internal structure (two- and multilayer) was compared on specimens with the identical total thickness of the protective layer equal to 500–600 μm (Figure 6). Analysis of the results showed that decrease in temperature of the protected substrate, showing the effi-



Figure 7. Piston of aluminium alloy with thermal barrier coating

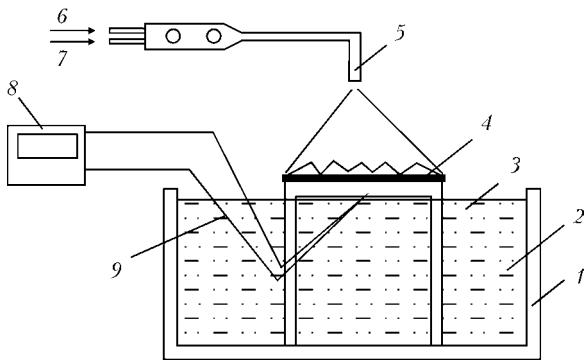

Figure 8. Schematic of the rig for testing heat-protecting properties of quasi-crystalline coatings: 1 – bath; 2 – water; 3 – piston; 4 – coating; 5 – gas flame torch; 6 – oxygen; 7 – propane; 8 – instrument UT70B; 9 – thermocouple

ciency of heat protection provided by the coatings, depends on the following factors:

- coating composition. The AlCuFe coatings as a metallic component are superior to the NiCrAlY coatings (the value of T_{max} is 24–47 °C lower);
- coating structure. The highest effect is achieved with the five-layer (graded) coatings, which are superior to the traditional two-layer ones (decrease in T_{max} is 125–135 °C, compared to 95 °C);
- deposition method. For all the coatings investigated, the plasma method is advantageous over the detonation one (difference in decrease in T_{max} is 20–30 °C).

The efficiency of protection grows with increase in thickness of the protective layer. However, in this case the level of internal stresses leading to separation of a coating from the substrate because of differences in LTEC also grows. From this standpoint, the AlCuFe coatings are advantageous over the NiCrAlY ones when they are deposited on aluminium alloys, which is attributable to closeness of their LTEC. The data shown in Figure 6 are indicative of the presence of an optimal value of the coating thickness, which is related to its diminishing effect on the efficiency of heat protection.

As the given results proved a high potential of the AlCuFe coatings containing the quasi-crystalline ψ -phase in use as thermal barrier ones for components of ICEs made from aluminium alloys, it is of interest to study their behaviour under the conditions close to service ones for the ICEs.

The AlCuFe plasma coating produced by spraying a powder with 45 % of the quasi-crystalline ψ -phase, the detonation coating of the AlCuFeTiCrSi powder containing 50 % of the approximant α -phase and, for comparison, the ZrO₂ plasma coating with a bond coat of alloy NiCrAlY were tested. The coatings were applied to an ICE piston with a diameter of 78 mm and 76 mm high, made from the aluminium alloy (Figure 7). Thickness of the coatings was (450 ± 50) μm. The tests were carried out on a rig (Figure 8) by heating the piston surface with a torch located at a distance of (55 ± 5) cm from the piston surface. Heat-

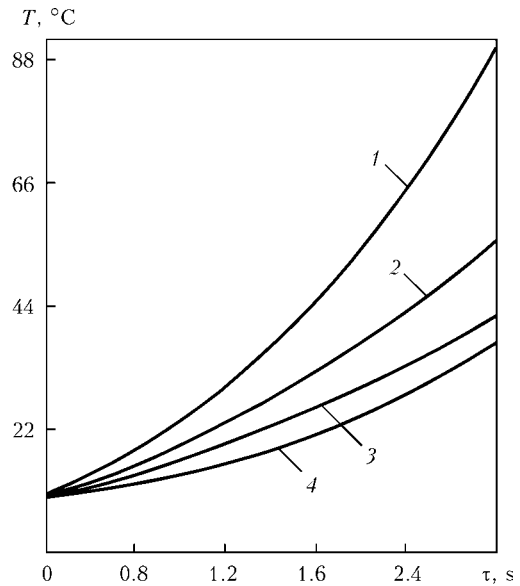

Figure 9. Dynamics of heating of a piston with the gas torch: 1 – without coating; 2 – ZrO₂ with NiCrAlY bond coat; 3 – AlCuFe; 4 – AlCuFeTiCrSi

ing was performed for 3 s, and cooling – for 30 s. The dynamics of heating of the piston bottom was averaged over the results of 10 thermal cycles (Figure 9).

It was established that the ultimate temperature of the piston bottom heated for 3 s by the flame of the gas torch at the absence of a coating was 102 °C, and that for the ZrO₂ coatings with the NiCrAlY, AlCuFe and AlCuFeTiCrSi bond coats was 71, 60 and 56 °C, respectively.

The experimental data obtained on behaviour of materials of the Al–Cu–Fe system alloy containing the quasi-crystalline ψ -phase, and of the Al–Cu–Fe–Ti–Cr–Si system alloy with an approximant structure (α -phase) used as thermal barrier coatings on the surfaces of aluminium alloy components are indicative of their high efficiency. Under conditions of cyclic heating with a propane-oxygen jet of the torch, they are superior in the indicator of a maximum achievable temperature of the substrate to the traditional two-layer thermal barrier coating, i.e. NiCrAlY/ZrO₂. Such thermal-physical properties of the investigated coatings, along with the LTEC values close to those of aluminium alloys, make them promising for development of TBCs for diesel engines manufactured from light alloys. In operation of ICE with a TBC the losses of heat in the cooling system will be reduced, the working temperature in the combustion chamber will be increased, and the technical and economic indices of operation of a diesel engine will be improved. Decrease in temperature of the engine components will allow intensity of their wear to be reduced.

1. Iliushchenko, A.F., Ivashko, V.S., Okovity, V.A. et al. (1998) *Thermal barrier coatings based on ZrO₂*. Minsk: NII PM.
2. Kolomytsev, P.T. (1991) *High-temperature protective coatings for nickel alloys*. Moscow: Metallurgiya.



3. Nikitin, M.D., Kulik, A.Ya., Zakharov, N.I. (1977) *Thermal barrier and wear-resistant coatings for diesel components*. Leningrad: Mashinostroenie.
4. Zhu, D., Miller, R.A. (1999) Thermal barrier coatings for advanced gas turbine and diesel engines. In: *NASA/TM 209453*.
5. Moskal, G. (2009) Thermal barrier coatings: characteristics of microstructure and properties. Generation and directions of development of bond. *J. Achiev. in Mat. and Manufac. Eng.*, **37**(2), 323–331.
6. Soltani, R., Samadi, H., Garcia, E. et al. (2005) Development of alternative thermal barrier coatings for diesel engines. In: *Proc. of SAE Int.* (Toronto, 2005), **1**.
7. Buyukkaya, E., Engine, T., Cerit, M. (2006) Effects of thermal barrier coating on gas emissions and performance of a LNR engine with different injection timings and valve adjustments. *Energy Conversion and Management*, **47**, 1298–1310.
8. Bailey, N., Mill, B., Whyman, P. (2011) New, low cost thermal barrier coating developed specifically for diesel engine applications to solve heat issues associated with 2013 Euro VI emissions introduction. *Automotive Industry Today*, **2**.
9. Huttunen-Saarivirta, E. (2004) Microstructure, fabrication and properties of quasicrystalline Al–Cu–Fe alloys: a review. *J. Alloys and Compounds*, **363**, 150–174.
10. Adeeva, L.I., Borysova, A.L. (2002) Quasi-crystalline alloys as a new advanced material for protective coatings. *Fizyka i Khimiya Tv. Tila*, **3**(3), 454–464.
11. Borysova, A.L., Borysov, Yu.S., Adeeva, L.I. et al. (2005) Thermal spray coatings containing quasi-crystalline phase, properties and applications (Review). *Ibid.*, **6**(1), 124–136.
12. Haberkern, R., Lindqvist, P., Fritsch, G. (1993) Transport properties of quasicrystalline AlCuFe. *J. Non-Crystalline Solids*, **153/154**, 303–307.
13. Edagawa, K., Kajiyama, K., Takeuchi, S. (1999) Thermal expansion and Gruneisen parameters of quasicrystals. *Mat. Res. Soc. Symp. Proc.*, **553**, 403–408.
14. Borisov, Yu.S., Borisova, A.L., Golnik, V.F. et al. (2007) Corrosion resistance of thermal spray coatings of quasi-crystalline phase-containing AlCuFe base alloys. *The Paton Welding J.*, **2**, 27–31.
15. Rudiger, A., Koster, U. (2000) Corrosion behavior of Al–Cu–Fe quasicrystals. *Mat. Sci. and Eng.*, **294/296**, 890–893.
16. Chungen Zhou, Rui Cai, Shengkai Gong et al. (2006) Hot corrosion of AlCuFeCr quasicrystalline coating on titanium alloys with NaCl deposit. *Surface and Coatings Techn.*, **201**, 1718–1723.
17. Massiani, Y., Ait Yaazza, S., Dubois, J.M. (1995) Electrochemical corrosion behaviour of quasicrystalline coatings in dilute acetic acid. In: *Proc. of 5th Int. Conf. on Quasicrystals*, 790–793.
18. Srinival, V., Barua, P., Chosh, T.B. et al. (2004) Oxidation behavior of Al–Cu–Fe nanoquasicrystal powders. *J. Non-Crystalline Solids*, **334/335**, 540–543.
19. Yamasaki Michiaki, Tsai An Pang (2002) Oxidation behavior of quasicrystalline Al₆₃Cu₂₅Fe₁₂ alloys with additional elements. *J. Alloys and Compounds*, **342**, 473–476.
20. Sanchez, A., Garcia de Blas, F.J., Algaba, J.M. et al. (1999) Application of quasicrystalline materials as thermal barriers in aeronautics and future perspectives of use for these materials. *Mat. Res. Soc. Symp. Proc.*, **553**, 447–457.
21. Haugeneder, A., Eisenhammer, T., Mahr, A. et al. (1997) Oxidation of quasicrystalline and crystalline AlCuFe thin film in air. *Thin Solid Films*, **307**, 120–125.
22. Dubois, J.M., Kang, S.S., Von Stebut, J. (1991) Quasicrystalline low-friction coatings. *J. Mat. Sci. Lett.*, **10**, 537–541.
23. Solderet, D.J., Krotz, P.D., Daniel, R.L. et al. (1995) Microstructure and wear behavior of quasicrystalline thermal sprayed coatings. In: *Proc. of 8th Nat. Thermal Spray Conf.* (Houston, Sept. 11–15, 1995), 627–632.
24. De Palo, S., Usmani, S., Sampath, S. et al. (1997) Friction and wear behavior of thermally sprayed Al–Cu–Fe quasicrystal coatings. *Ibid.*, 135–139.
25. Galano, M., Audebert, F., Garcia Escorial, A. et al. (2009) Nanoquasicrystalline Al–Cu–Fe-based alloys. Pt 2: Mechanical properties. *Acta Mater.*, **57**, 5120–5130.
26. Goldman, A.I., Kelton, R.F. (1993) Quasicrystals and crystalline approximants. *Amer. Phys. Soc. Rev. of Modern Physics*, **65**(1), 213–230.
27. Borisova, A.L., Tunik, A.Yu., Adeeva, L.I. et al. (2010) Thermal barrier multilayer plasma coatings ZrO₂–NiCrAlY. *The Paton Welding J.*, **10**, 22–28.
28. Borisova, A.L., Adeeva, L.I., Tunik, A.Yu. et al. (2010) Plasma ZrO₂ coatings with metallic bond coat of alloy Al–CuFe. *Ibid.*, **4**, 25–29.
29. Astakhov, E.A., Kaplina, G.S., Kokorina, N.N. et al. (2009) Study of structure and phase composition of detonation thermal-barrier coatings from quasi-crystalline alloys. In: *Proc. of Int. Conf. on Materials for Service in Extreme Conditions* (Kiev, 29–30 Sept. 2009), 101–105.