

ELECTRON BEAM 3D-DEPOSITION OF TITANIUM PARTS

S.V. AKHONIN, E.L. VRZHIZHEVSKY, V.Yu. BELOUS and I.K. PETRICHENKO

E.O. Paton Electric Welding Institute, NASU

11 Kazimir Malevich Str., 03680, Kiev, Ukraine. E-mail: office@paton.kiev.ua

At present 3D-printing and additive technologies are given a lot of attention in research centers all over the world. In connection with the fact that titanium is a reactive metal, electron beam technologies appear to be the most promising for development of the technology of metal 3D-deposition of parts from titanium-based alloys. The work is a study of the possibility of development of electron beam deposition of complex shapes from commercial titanium. Deposition was performed with application of 2-coordinate manipulator and moving work table, the part was formed on a titanium substrate, titanium welding wire of VT1-00 grade was used as filler material. Parts of rectilinear shape of 35 mm height and of cylindrical shape of 45 mm height with 10 mm wall thickness were produced. Deposited layer structures were studied, and absence of metal porosity in cylindrical and rectilinear deposits was noted. Structure of deposited metal layers is similar to that of cast metal of commercial titanium VT1-0. Microhardness of metal of the part produced by electron beam 3D-deposition with application of VT1-00 welding wire corresponds to the level of microhardness of cast metal of commercial titanium VT1-0. It is shown that electron beam deposition technology allows producing parts of a complex shape from titanium of a homogeneous structure. 4 Ref., 9 Figures.

Keywords: 3D-printing, electron beam 3D-deposition, electron beam, titanium, structure

At present 3D-printing and additive technologies are given a lot of attention in research centers all over the world [1]. In case of fabrication of metal parts, technologies are developed, which use laser (so-called SLS-technologies [2]) or electron beam as the heat source. Sciaky Company specializing on development of welding technologies and equipment is developing a technology, according to which the part is created by the method of layer-by-layer deposition of material in the melt, formed by the electron beam (so-called Electron Beam Direct Manufacturing) [3].

In connection with the fact that titanium is a reactive material, EB technologies in the vacuum chamber,

providing the most reliable protection of molten and cooling metal, are seen by us as the most promising for development of the technology of direct manufacturing of metal parts from titanium by 3D-deposition of metallic materials [4]. In this case, it is possible to use standard welding consumables, widely applied for performance of welding and surfacing operations.

The objective of the work was studying the possibility of producing parts from a titanium alloy by the method of EB 3D-deposition with application of titanium-based filler wires.

EB 3D-deposition was performed in upgraded UL-144 unit, fitted with ELA 60/60 power unit, special welding gun and specialized feed mechanism for feeding the filler wire in electron beam chamber.

During performance of the work, the possibility of manufacturing two types of parts was studied, namely of the shape of body of revolution, and of rectilinear shape.

Application of the body of revolution to manufacture 3D-parts is a simpler task. Performed studies allowed optimizing the technology of 3D-deposition with application of continuously maintained molten metal pool. Schematic of the process of EB 3D-deposition of the body of revolution is shown in Figure 1.

Continuously maintained pool of molten metal was used at 3D-deposition of the part — sleeve, which is the body of revolution. During 3D-deposition of the body of revolution, the EB gun moves in the horizontal plane together with the mechanism for feeding filler metal in the form of wire. The part is

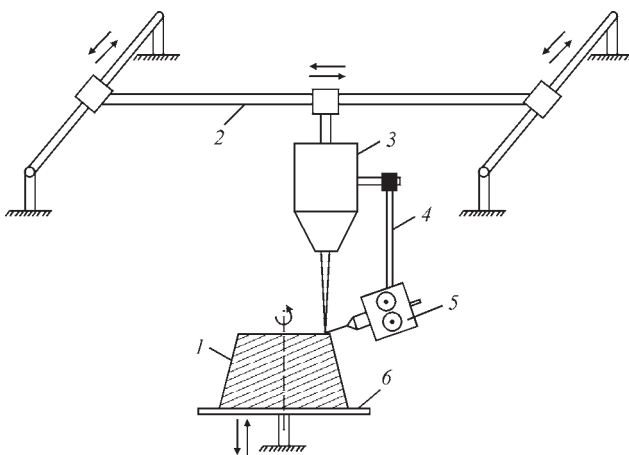

Figure 1. Schematic of EB 3D-deposition of body of revolution with application of continuously maintained pool: 1 — manufactured item; 2 — manipulator; 3 — EB gun; 4 — rod of feed mechanism holder; 5 — feed mechanism; 6 — rotary table with vertical displacement mechanism

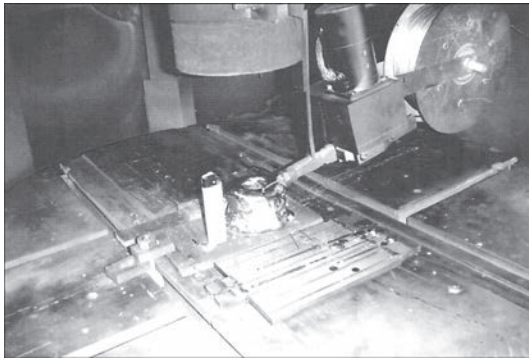

Figure 2. Position of the part of the shape of body of revolution and filler wire feed mechanism in the chamber of EB unit

formed on a water-cooled forming substrate, making rotational motion. As the layer is deposited, the table with the fixed part and water-cooled forming substrate moves downwards. Here, the distance between the filler wire and EB gun cathode is fixed, and does not change during the process of making of the entire part. An example of the part, having the shape of the body of revolution, is shown in Figures 2 and 3.

However, technological capabilities of the method of 3D-deposition with application of continuously maintained pool are limited. Technology of layer-by-layer 3D-deposition with application of periodically formed molten metal pool opens up many more possibilities.

A technique was experimentally worked out to make a part of a rectilinear shape, which is a vertical wall, formed on a metal substrate. In 3D-deposition of a rectilinear part, EB gun and feed mechanism move in the horizontal plane, here the distance between the filler wire and EB gun cathode is also fixed, and does not change during the process of manufacturing of the entire part. As the layer is deposited, the table with the fixed part and substrate moves downwards. Beam scanning and focusing were performed by a special program, to ensure the required dimensions of molten metal pool.

In the case of 3D-deposition of a part of a rectilinear shape, after deposition of the next layer, molten metal pool was formed in the starting point anew.

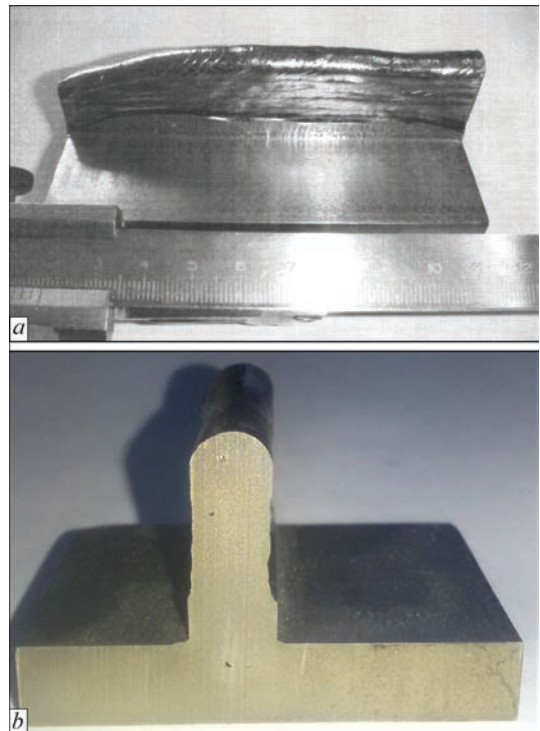

Figure 4. Sample of rectilinear-shaped part manufactured by EB 3D-deposition with application of periodically formed molten metal pool: *a* — appearance; *b* — rectilinear part cross-section

3D-deposition of a rectilinear-shaped part was performed on a substrate of titanium of VT1-00 grade 10 mm thick. During deposition, the substrate moved in the vertical direction, and the EB gun and feed mechanism moved in the horizontal plane. Number of layers required for the wall of a part of 35 mm height and 8 mm width was 18 passes. Filler wire feeding, creation of molten metal pool and pool movement over the formed part surface were performed by an automatic complex program. The program allows changing the height and width of the formed part wall in a broad range. An example of a rectilinear-shaped part is given in Figure 4.

Conducted studies of manufactured parts showed that in the case of application of VT1-00 welding wire as building material for EB 3D-deposition, and of commercial titanium VT1-00 10 mm thick as the substrate material, the deposited layer structure is similar

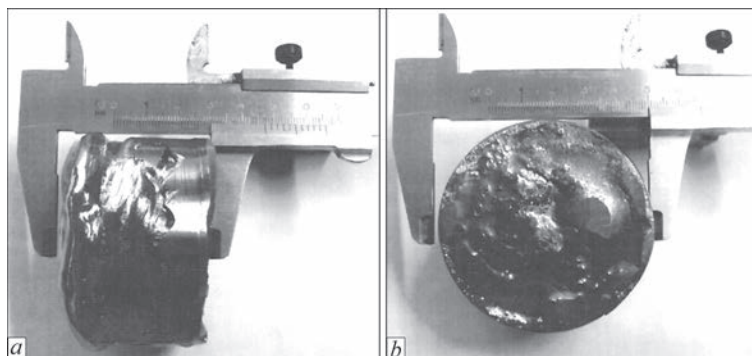

Figure 3. Appearance of the part of the shape of body of revolution: *a* — side view; *b* — top view

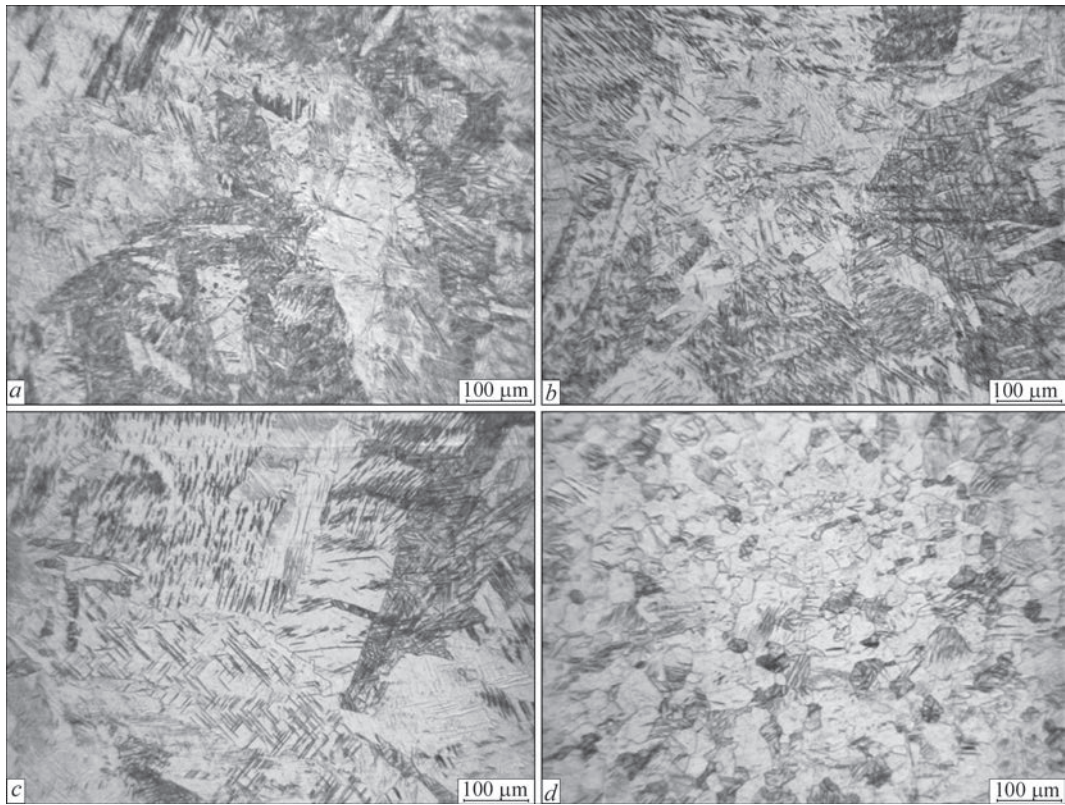

Figure 5. Structure of metal of a rectilinear part manufactured by EB 3D-deposition: *a-c* — deposited metal; *d* — substrate metal

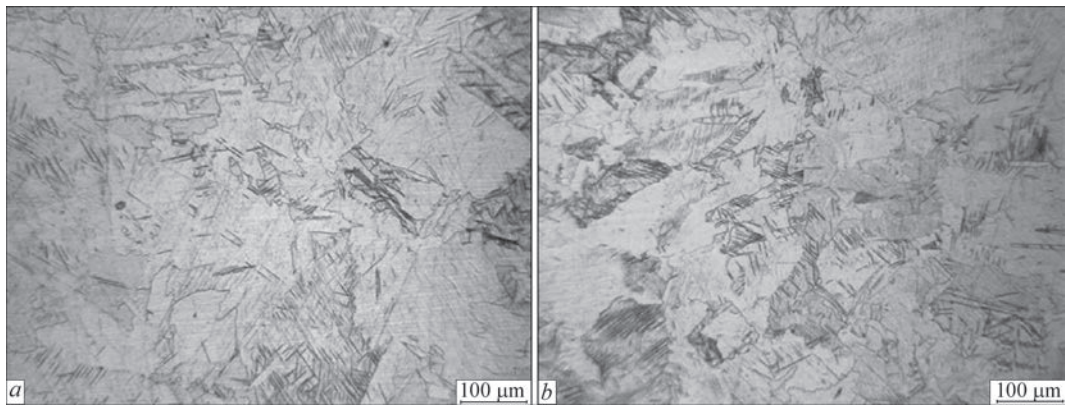

Figure 6. Structure of HAZ metal of a rectilinear part made by EB 3D-deposition: *a* — near deposited metal; *b* — near substrate metal

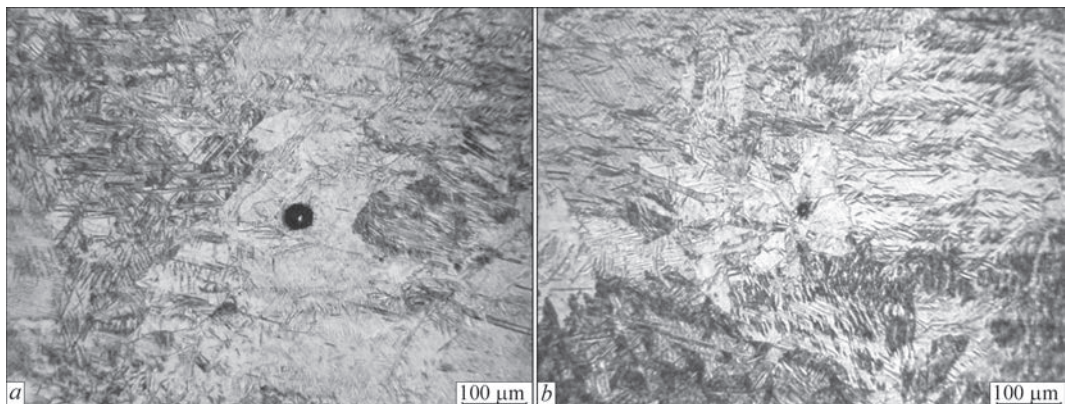

Figure 7. Structure of deposited metal of a rectilinear part made by EB 3D-deposition

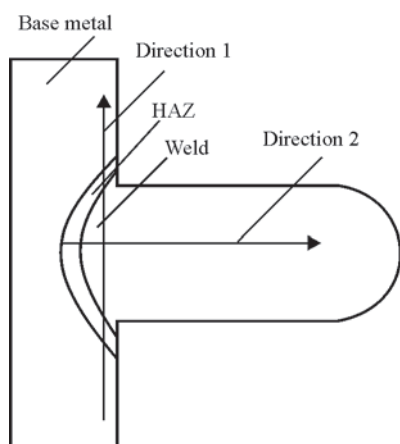

Figure 8. Schematic of measurement of microhardness of deposited metal of a rectilinear part made by EB 3D deposition

to that of cast metal of the base alloy. Deposited metal of filler wire of VT1-00 grade consists of coarse irregular-shaped grains with serrated boundaries (Figure 5, *a–c*), grain size being 0.5–3.0 mm, and most of the grains have twins. Substrate metal has more fine-grained structure and consists of equiaxed grains of α -phase of 10–50 μm size (Figure 5, *d*) with twins present in some grains.

Despite the fact that deposition was performed in several layers, no fusion zones between the layers are revealed structurally in the cross-section. Figure 6 presents microstructures of the metal of HAZ from the deposit. HAZ region, where the metal went through phase recrystallization during deposition, consists of grains of irregular shape with serrated boundaries, similar to deposited metal. Size of HAZ grains decreases with greater distance from the deposited metal (Figure 6). Twins are also present in HAZ metal grains. No defect, characteristic for EBW, such as microporosity, was found during deposited metal examination.

However, one pore of about 35 μm diameter (Figure 7, *a*) and several fine pores of less than 10 μm diameter (Figure 7, *b*) were detected, when studying deposited metal of rectilinear part of 10×25 mm cross-section. No other defects were found. Small number of pores is, probably, attributable to greater duration of molten metal pool existence, compared to welding modes.

Measurement of microhardness of deposited metal of a rectilinear part (Figure 8), made by EB 3D-depo-

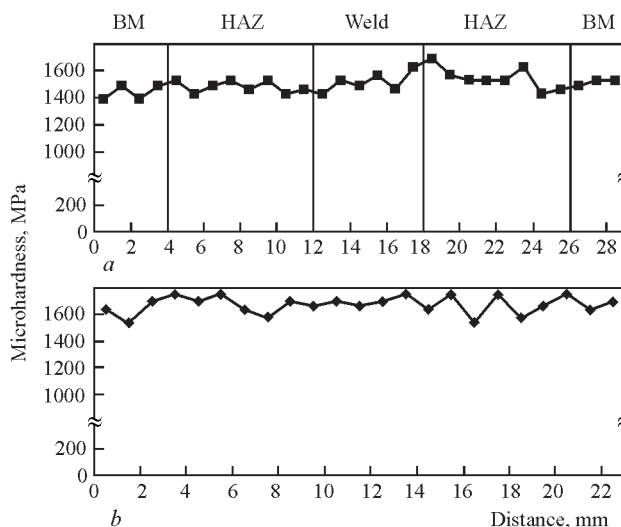

Figure 9. Microhardness of deposited metal of a rectilinear part manufactured by EB 3D-deposition in direction 1 (*a*) and 2 (*b*) (acc. to Figure 8)

sition, showed that its microhardness is on the level of substrate metal, that leads to the assumption that mechanical properties of deposited part metal will correspond to the level of cast metal of base titanium alloy (Figure 9).

Conclusions

1. A technique of 3D-deposition was developed which allows manufacturing two types of parts of the shape of bodies of revolution and of rectilinear shape.
2. In the case of application of titanium α -alloy VT1-00 as base metal, deposited layer structure is similar to that of cast metal of base titanium alloy.
3. Microhardness of metal of the part made by EB 3D-deposition corresponds to the level of microhardness of cast metal of base titanium alloy.

1. Hideki Kyogoku (2015) The current status and outlook for metal additive manufacturing in Japan. *Metal Additive Manuf.*, 1(3), 31–39.
2. Dutta, B., Froes, F.H. (2015) The additive manufacturing (AM) of titanium alloys. In: *Titanium powder metallurgy*, 447–468.
3. Xiaoqing Wang, Xibing Gong, Kevin Chou (2015) Scanning speed effect on mechanical properties of Ti–6Al–4V alloy processed by electron beam additive manufacturing. In: *Proc. of 43rd North American Manuf. Res. Institution of SME*, Vol. 1, 287–295.
4. Whittaker, D. (2015) Development in the additive manufacturing of titanium at PM titanium. *Metal Additive Manuf.*, 1(3), 53–60.

Received 19.02.2016